

HYDRTHERM™

OWNERS MANUAL

DYNAMIC/X8 - GEN 6



Congratulations on purchasing your new **HYDR****THERM**[™] system.

Congratulations on your purchase of Australia's best-value and top-performing heat pump. Our team has dedicated themselves to designing and developing the Hydrotherm range to ensure that every unit provides years of trouble-free operation. However, to ensure optimal performance, it is crucial to install and operate your Hydrotherm in line with the instructions provided in this manual. Once operational, there is little maintenance required, and you can enjoy an abundance of affordable hot water.

CONTENTS

1.0	SAFETY WARNINGS	
	1.1 INSTALLATION & OPERATION	p. 5
	1.2 WARNING - FLAMMABLE REFRIGERANT	p. 5
	1.3 REPAIRS & MAINTENCE	pp. 6 - 7
2.0	SPECIFICATIONS	p. 8
3.0	PERFORMANCE	p. 9
4.0	PARTS & CONSTRUCTION SCHEMATICS	
	4.1 DYNAMIC/X8 DIMENSIONS	p. 10
	4.2 DYNAMIC/X8 PARTS SCHEMATICS	p. 10
5.0	INSTALLATION INSTRUCTIONS	
	5.1 DELIVERY	p. 11
	5.2 BASE	p. 12
	5.3 AIRFLOW	p. 13
	5.4 NOISE CONSIDERATIONS	p. 14
6.0	HEAT PUMP - OPERATING PRINCIPLE	p. 14
7.0	PLUMBING SCHEMATICS	
	7.1 DYNAMIC/X8 CONNECTION DIMENSIONS & COMPONENTS	p. 15
8.0	PLUMBING INSTALLATION	
	8.1 PLUMBING CONNECTIONS	p. 16
	8.1.1 COLD WATER SUPPLY OUTLET	p. 16
	8.1.2 Hot water connection	p. 16
	8.1.3 Condensate Drain	p. 16
	8.1.4 Pressure & Temperature Relief (PTR) Valve	p. 17
	8.1.5 Tempering Valve	p. 17
	8.1.6 Expansion Control Valve	p. 17
	8.1.7 Pressure Reducing Valve	p. 18
	8.1.8 Non-return/Isolating Valve	p. 18
	8.1.9 Water Quality	p. 18
9.0	PLUMBING MAINTENANCE	
	9.1 OPERATING P.T.R VALVE	p. 19
	9.2 CHECKING THE ANODE & REPLACING IF REQUIRED	p. 19
	9.3 CLEANING THE INNER TANK	p. 19
10.0	ELECTRICAL SCHEMATICS & CONNECTIONS	
	10.1 ELECTRICAL SCHEMATIC	p. 20
	10.2 PRE-CONNECTION & REGULATIONS	p. 21
	10.3 CONNECTING TO POWER SUPPLY	p. 22
	10.4 ELECTRICAL TESTING	p. 22
11.0	COMMISSIONING THE SYSTEM	
	11.1 PRE-START PROCEDURES & CHECKS	p. 23

12.0 OPERATION PANEL INSTRUCTIONS

12.1 ACCESSING THE DISPLAY PANEL	p. 25
12.2 TURNING ON	p. 26
12.3 SETTING DATE & TIME	pp. 26 - 27
12.4 SETTING HEATING TIMER WINDOWS	pp. 27 - 28
12.5 HEATING MODES	p. 29
12.6 SELECTING A HEATING MODE	p. 30
12.7 WI-FI CONFIGURATION	p. 30
12.8 SYSTEM DIAGNOSTICS	p. 31
12.9 SYMBOLS & ICONS	p. 32
12.10 FAULTS & ERROR CODES	p. 33
12.11 LEGIONELLA CONTROL STRATEGY	p. 33

13.0 MAINTENANCE - OWNER

13.1 SIX MONTH MAINTENANCE	p. 34
13.2 MAINTENANCE NOTES	p. 35

14.0 MAINTENANCE - TRADESPERSON

p. 36

15.0 TROUBLE SHOOTING

pp. 37 - 38

16.0 WARRANTY

pp. 39 - 43

SYMBOLS USED IN THIS MANUAL



Please Note:
Warning about possible dangers.



Please Note:
Important information and tips.



Important information regarding
flammable materials.



Australian Standard
AS/NZS2712:2007
SMK40937
SAI Global



Water Mark
AS 3498 Lic WMK 26182

This appliance must be installed in accordance with:

- Manufacturer's Installation Instructions
- Current AS/NZS 3500• Plumbing Code of Australia (PCA)
- Local Regulations and Municipal Building Codes including local OH&S requirements

This system must be installed, commissioned, serviced, maintained and removed **ONLY** by an Authorised Person.

NOT SUITABLE AS A POOL OR SPA HEATER

For continued safety of this appliance it must be installed and maintained in accordance with the manufacturer's instructions.

Please carefully read these operating and installation instructions and keep them safe. Should this system change hands, pass these instructions to the subsequent owner. Additionally, provide this document to any trained contractor for servicing proposes.

SAFETY PRECAUTIONS



INSTALLATION & OPERATION.

- For optimal performance, this device must be installed in a well-ventilated environment. If used indoors, the appliance must be placed, operated, and stored in a room with a floor area of at least 47m².
- DO NOT install or operate this system before reading the manufacturer's instructions.
- This appliance must be installed, commissioned and serviced by an authorised person in accordance with all applicable local rules and regulations.
- Removing access cover or water heating system components will expose 240V wiring and MUST only be removed by an authorised person.
- If the system's power supply is damaged, it MUST BE replaced by an authorised person to avoid a hazard. Take care not to touch the power connections or plugs with wet hands.
- This appliance is not intended for use by persons (including children) with reduced physical, sensory or mental capabilities or lack of experience and knowledge unless they have been given supervision or instruction concerning the use of the appliance by a person responsible for their safety. Children should be supervised to ensure they DO NOT play with the appliance.
- For continued safety of this appliance, it must be installed, operated and maintained per the manufacturer's instructions.
- The electrical connection to this product must be via a 20A RCD/MCB or RCBO with a test button function.
- Care should be taken not to touch the pipework as it may be HOT!
- DO NOT place articles on or against this appliance.
- DO NOT store chemicals or flammable materials near this appliance.
- DO NOT operate with collectors or covers removed from this appliance.
- DO NOT activate the heat pump unless the cylinder is full of water.
- Household electrics must have a reliable earth connection.
- This product must be protected with a residual current device of adequate rating.
- Do not interfere with any permanent instructions, labels or warning plates attached to the external cover of this heat pump.
- This product must be installed by a qualified person in the mechanical and electrical industry.
- Always comply with local wiring regulations.
- Always engage with a trained professional to relocate this product after it is installed.
- Maintenance and repair work must only be undertaken by trained and qualified personnel.



FLAMMABLE MATERIALS.

- This appliance uses R290 (propane) refrigerant, which is a flammable gas class 3 according to AS 1677 and must be handled by a refrigeration mechanic with an appropriate Australian refrigerant handling license.
- WARNING Risk of fire/flammable material. If the refrigerant is leaked, together with an external ignition source, there is a possibility of ignition.
- DO NOT store chemicals or flammable materials near this appliance.
- NEVER use a flammable spray such as hair spray, paint, etc near this unit as this may cause a fire.
- The appliance should not be stored or transported in an area with an ignition source (e.g. open flame, an operating gas appliance or an operating electric heater.).
- Do not pierce or burn the appliance.
- Be aware that the refrigerant may not cause an odour.
- Compliance with AS/NZS 5601 must be observed while storing the appliance.
- National and state regulations exist for the storage, transportation and handling of hazardous goods including flammable gasses. The maximum number of and configuration of the equipment permitted to be transported or stored together will be determined by the appliance regulations.
- If used indoors, the appliance must be placed, operated, and stored in a room with a floor area of at least 47m² and any required ventilation openings clear of obstruction
- The room's air extraction opening shall be equal or below the refrigerant release point. For floor mounted units, it shall be as low as practicable. The air extraction openings shall be located in a sufficient distance from the air intake openings to prevent recirculation to the space.



WARNING ABOUT POSSIBLE DANGERS

If the hot water system is not used for two weeks or more, a quantity of highly flammable hydrogen gas may accumulate in the water heater. To dissipate this gas safely, it is recommended that a hot tap be turned on for several minutes or until the discharge of gas ceases. Use a sink, basin, or bath outlet, but not a dishwasher, clothes washer, or other appliance. During this procedure, there must be no smoking, open flame, or any electrical appliance operating nearby. If hydrogen is discharged through the tap, it will probably make an unusual sound as with air escaping.



MAINTENANCE AND REPAIR WORK TO ONLY BE UNDERTAKEN BY TRAINED AND QUALIFIED PERSONNEL.

- Prior to beginning work on systems containing flammable refrigerants, safety checks are necessary to ensure that the risk of ignition is minimised.
- Work shall be undertaken under a controlled procedure so as to minimise the risk of a flammable gas or vapour being present while the work is being performed.
- All maintenance staff and others working in the local area shall be instructed on the nature of work being carried out. Work in confined spaces shall be avoided.
- The area shall be checked with an appropriate refrigerant detector prior to and during work, to ensure the technician is aware of potentially toxic or flammable atmospheres. Ensure that the leak detection equipment being used is suitable for use with all applicable refrigerants, i.e. non-sparking, adequately sealed or intrinsically safe.
- If any hot work is to be conducted on the refrigerating equipment or any associated parts, appropriate fire extinguishing equipment shall be available to hand. Have a dry powder or CO₂ fire extinguisher adjacent to the charging area.
- No person carrying out work in relation to a refrigerating system which involves exposing any pipe work shall use any sources of ignition in such a manner that it may lead to the risk of fire or explosion.
- All possible ignition sources, including cigarette smoking, should be kept sufficiently far away from the site of installation, repairing, removing and disposal, during which refrigerant can possibly be released to the surrounding space.
- Prior to work taking place, the area around the equipment is to be surveyed to make sure that there are no flammable hazards or ignition risks. "No Smoking" signs shall be displayed.
- Ensure that the area is in the open or that it is adequately ventilated before breaking into the system or conducting any hot work.
- A degree of ventilation shall continue during the period that the work is carried out.
- The ventilation should safely disperse any released refrigerant and preferably expel it externally into the atmosphere.
- Where electrical components are being changed, they shall be fit for the purpose and to the correct specification.
- At all times the manufacturer's maintenance and service guidelines shall be followed. If in doubt, consult the manufacturer's technical department for assistance.
- Repair and maintenance to electrical components shall include initial safety checks and component inspection procedures.
- If a fault exists that could compromise safety, then no electrical supply shall be connected to the circuit until it is satisfactorily dealt with. If the fault cannot be corrected immediately but it is necessary to continue operation, an adequate temporary solution shall be used. This shall be reported to the owner of the equipment so all parties are advised.
- Initial safety checks shall include: that no live electrical components and wiring are exposed while charging, recovering or purging the system; that there is continuity of earth bonding.
- During repairs to sealed components, all electrical supplies shall be disconnected from the equipment being worked upon prior to any removal of sealed covers, etc.
- If it is absolutely necessary to have an electrical supply to equipment during servicing, then a permanently operating form of leak detection shall be located at the most critical point to warn of a potentially hazardous situation.
- Particular attention shall be paid to the following to ensure that by working on electrical components, the casing is not altered in such a way that the level of protection is affected. This shall include damage to cables, excessive number of connections, terminals not made to original specification, damage to seals, incorrect fitting of glands, etc.
- Ensure that seals or sealing materials have not degraded to the point that they no longer serve the purpose of preventing the ingress of flammable atmospheres.
- Replacement parts shall be in accordance with the manufacturer's specifications.
- Do not apply any permanent inductive or capacitance loads to the circuit without ensuring that this will not exceed the permissible voltage and current permitted for the equipment in use.
- Intrinsically safe components are the only types that can be worked on while live in the presence of a flammable atmosphere. The test apparatus shall be at the correct rating.
- Replace components only with parts specified by the manufacturer. Other parts may result in the ignition of refrigerant in the atmosphere from a leak.
- Check that cabling will not be subject to wear, corrosion, excessive pressure, vibration, sharp edges or any other adverse environmental effects.
- The check shall also take into account the effects of aging or continual vibration from sources such as compressors or fans.
- Under no circumstances shall potential sources of ignition be used in the searching for or detection of refrigerant leaks. A halide torch (or any other detector using a naked flame) shall not be used.
- Electronic leak detectors may be used to detect refrigerant leaks but, in the case of flammable refrigerants, the sensitivity may not be adequate, or may need recalibration.
- Ensure that the detector is not a potential source of ignition and is suitable for the refrigerant used. Leak detection equipment shall be set at a percentage of the LFL of the refrigerant and shall be calibrated to the refrigerant employed, and the appropriate percentage of gas (25 % maximum) is confirmed.
- Leak detection fluids are also suitable for use with most refrigerants but the use of detergents containing chlorine shall be avoided as the chlorine may react with the refrigerant and corrode the copper pipe-work.
- If a leak is suspected, all naked flames shall be removed/extinguished.
- If a leakage of refrigerant is found which requires brazing, all of the refrigerant shall be recovered from the system, or isolated (by means of shut off valves) in a part of the system remote from the leak.

- When breaking into the refrigerant circuit to make repairs – or for any other purpose – conventional procedures shall be used. However, for flammable refrigerants it is important that best practice is followed since flammability is a consideration. The following procedure shall be adhered to:
 - a. remove refrigerant;
 - b. purge the circuit with inert gas;
 - c. evacuate;
 - d. purge with inert gas;
 - e. open the circuit by cutting or brazing.
 - f. The refrigerant charge shall be recovered into the correct recovery cylinders.
 - g. This process may need to be repeated several times. Compressed air or oxygen shall not be used for purging refrigerant systems.
- For appliances containing flammable refrigerants, other than A2L refrigerants, refrigerants purging shall be achieved by breaking the vacuum in the system with oxygen-free nitrogen and continuing to fill until the working pressure is achieved, then venting to atmosphere, and finally pulling down to a vacuum.
- This process shall be repeated until no refrigerant is within the system.
- When the final oxygen-free nitrogen charge is used, the system shall be vented down to atmospheric pressure to enable work to take place.
- Ensure that the outlet for the vacuum pump is not close to any potential ignition sources and that ventilation is available.
- In addition to conventional charging procedures, the following requirements shall be followed.
- Ensure that contamination of different refrigerants does not occur when using charging equipment. Hoses or lines shall be as short as possible to minimise the amount of refrigerant contained in them.
- Cylinders shall be kept in an appropriate position according to the instructions.
- Ensure that the refrigerating system is earthed prior to charging the system with refrigerant.
- Label the system when charging is complete (if not already).
- Extreme care shall be taken not to overfill the refrigerating system.
- Prior to recharging the system, it shall be pressure-tested with the appropriate purging gas. The system shall be leak-tested on completion of charging but prior to commissioning. A follow up leak test shall be carried out prior to leaving the site.
- Before carrying out this procedure, it is essential that the technician is completely familiar with the equipment and all its detail.
- It is recommended good practice that all refrigerants are recovered safely. Prior to the task being carried out, an oil and refrigerant sample shall be taken in case analysis is required prior to re-use of recovered refrigerant. It is essential that electrical power is available before the task is commenced.
 - a. Become familiar with the equipment and its operation.
 - b. Isolate system electrically.
 - c. Before attempting the procedure, ensure that: mechanical handling equipment is available, if required, for handling refrigerant cylinders; all personal protective equipment is available and being used correctly; the recovery process is supervised at all times by a competent person; recovery equipment and cylinders conform to the appropriate standards.
 - d. Pump down refrigerant system, if possible.
 - e. If a vacuum is not possible, make a manifold so that refrigerant can be removed from various parts of the system.
 - f. Make sure that cylinder is situated on the scales before recovery takes place.
 - g. Start the recovery machine and operate in accordance with instructions.
 - h. Do not overfill cylinders (no more than 80 % volume liquid charge).
 - i. Do not exceed the maximum working pressure of the cylinder, even temporarily.
 - j. When the cylinders have been filled correctly and the process completed, make sure that the cylinders and the equipment are removed from site promptly and all
 - k. isolation valves on the equipment are closed off.
 - l. Recovered refrigerant shall not be charged into another refrigerating system unless it has been cleaned and checked.
- Equipment shall be labelled stating that it has been de-commissioned and emptied of refrigerant.
- The label shall be dated and signed.
- For appliances containing flammable refrigerants, ensure that there are labels on the equipment stating the equipment contains flammable refrigerant.
- When removing refrigerant from a system, either for servicing or decommissioning, it is recommended good practice that all refrigerants are removed safely.
- When transferring refrigerant into cylinders, ensure that only appropriate refrigerant recovery cylinders are employed. Ensure that the correct number of cylinders for holding the total system charge is available. All cylinders to be used are designated for the recovered refrigerant and labelled for that refrigerant (i.e. special cylinders for the recovery of refrigerant). Cylinders shall be complete with pressure-relief valve and associated shut-off valves in good working order. Empty recovery cylinders are evacuated and, if possible, cooled before recovery occurs.
- The recovery equipment shall be in good working order with a set of instructions concerning the equipment that is at hand and shall be suitable for the recovery of all appropriate refrigerants including, when applicable, flammable refrigerants. In addition, a set of calibrated weighing scales shall be available and in good working order. Hoses shall be complete with leak-free disconnect couplings and in good condition. Before using the recovery machine, check that it is in satisfactory working order, has been properly maintained and that any associated electrical components are sealed to prevent ignition in the event of a refrigerant release. Consult manufacturer if in doubt.
- The recovered refrigerant shall be returned to the refrigerant supplier in the correct recovery cylinder, and the relevant waste transfer note arranged. Do not mix refrigerants in recovery units and especially not in cylinders.
- If compressors or compressor oils are to be removed, ensure that they have been evacuated to an acceptable level to make certain that flammable refrigerant does not remain within the lubricant. The evacuation process shall be carried out prior to returning the compressor to the suppliers. Only electric heating to the compressor body shall be employed to accelerate this process. When oil is drained from a system, it shall be carried out safely

SPECIFICATIONS

TANK	
STORAGE VOLUME / HEATED VOLUME	267L / 263L
MATERIAL / THICKNESS	CARBON STEEL / DOME 3.0MM / WALL 2.5MM
COATING / RATING	BLUE DIAMOND VITEROUS ENAMEL / CLASS X
ANODE CORROSION PROTECTION	IMPRESSED CURRENT / 2 X MAGNESIUM BACKUP
DOMES DESIGN	CONCAVE TOP / CONVEX BASE
INSULATION / THICKNESS / HEAT LOSS RATING	POLYURETHANE / 40mm / 2.5kWh (24hrs)
EXTERNAL CASING	GALVANIZED SHEET / MATT SPRAY FINISH
PLUMBING	
PTR RATING & CONNECTION / WATER CONNECTIONS	850kPa & 1/2" G / 3/4" G
CONDENSATE DRAINAGE / PLV / ECV / TEMPERING VALVES	1/4" G / 500kPa / 700kPa / High Performance
HEAT PUMP	
REFRIGERANT/ CHARGE / MAX OPERATING PRESSURE	R290 / 400G / 3000kPa
COMPRESSOR BRAND / TYPE	GMCC TOSHIBA / ROTARY
EXPANSION VALVE / DEFROST / LOW TEMPERATURE CLASS	EEV / ACTIVE 4-WAY VALVE / CLASS A
FAN TYPE / DISCHARGE / FLOW RATE	CO-AXIAL / HORIZONTAL / 0.153 M ³ /S
FAN CAPACITOR / CONTROLS	1.5UF / DUAL-SPEED
EVAPORATOR DIMENSIONS / ROWS / MATERIAL	420MM X 350MM / 3 / COPPER
HEAT EXCHANGER - TYPE / MATERIAL	MICROCHANNEL / ALUMINUM TITANIUM ALLOY
OUTDOOR OPERATING NOISE @ 1.65M PER STANDARD ISO 3745:2012	42 (DB(A)) PRESSURE / 61 (DB(A)) POWER
ELECTRICS	
ELECTRICITY SUPPLY / MINIMUM CIRCUIT RATING	220-240 V/50-60HZ / 10 AMP - SINGLE PHASE
RECOMMENDED CIRCUIT CAPACITY / PROTECTION	16 AMP RCD/MCB OR RCBO WITH TEST BUTTON
COMPRESSOR MAX INPUT POWER / CURRENT / CAPACITY	900W / 3.75 Amp / 3450W
ELEMENT - RATING / MATERIAL / CONNECTION / THERMOSTAT	1800W/ INCOLOY / FLANGE / ROBERT SHAW
PROTECTION CLASS / ELECTRIC SHOCK PROOF	IPX4 / I
APPROVED POWER CONNECTIONS	DIRECT WIRE TO ISOLATOR / 3-PIN PLUG TO SOCKET
COMPATIBLE POWER TARIFFS	CONTINOUS / SHOULDER / T.O.U / SOLAR TIMERS
RATED INPUT @ AMPS - HEAT PUMP / ELECTRIC ELEMENT	1200W @ 5 AMP / 1800W @ 7.5 AMP
MAXIMUM RATED INPUT FOR CIRCUIT DESIGN / PTR RATING	1800W @ 7.5 AMP / 4100W
CONTROLLER	
INPUT / POWER / WI-FI / APP	TOUCH SCREEN / 3W / 2.4GHZ / TUYA
HEATING MODES	ECO STANDARD HYBRID HYBRID+ ELEMENT
DIMENSIONS @ WEIGHTS	
DIMENSIONS UNPACKED/ PACKED	620MM X 1800MM / 700MM X 700MM X 1700MM
WEIGHT UNPACKED/ PACKED / FILLED	115KG / 130KG / 375KG
PACKAGING	INDIVIDUAL SKID PALLET

HOUSEHOLD SIZING RECOMENDATIONS

CLIMATE (WARM = ZONES 1/2/3 | MILD = 4/5) / POWER TARIFF (CONTINOUS = 24hr | CONTROLLED = 6 -12hrs)

	MILD/CONTINOUS	MILD/CONTROLLED	COOL/CONTINOUS	COOL/CONTROLLED
MAXIMUM # OF OCCUPANTS	8	5	6	4
MAXIMUM # OF BEDROOMS	5	4	4	4
MAXIMUM # OF BATHROOMS	3	3	3	2

PERFORMANCE

VOLUMES & CAPACITY

AS4234 MODEL TO LOAD RATING	LARGE
VOLUME ABOVE TRIGGER SENSOR / ELEMENT	122L / 180L
STORED ENERGY CAPACITY STANDARD HYBRID HYBRID+	18.49kW 20.52kW 21.58kW
HOT WATER DELIVERY @ 45°C	STANDARD HYBRID HYBRID+
COLD WATER INLET @ 10°C	375L 405L 430L
COLD WATER INLET @ 15°C	395L 425L 455L
COLD WATER INLET @ 20°C	420L 460L 495L

TEMPERATURES

MAXIMUM WATER TEMPERATURE - HEAT PUMP / ELEMENT	60°C / 70°C
AMBIENT TEMPERATURE RANGE - HEAT PUMP / ELEMENT	-5°C to 43°C / -15°C to 50°C
LEGIONELLA CONTROL PROTECTION	45% of stored water heated to 60°C daily
MODE	REHEAT TRIGGER HEAT PUMP ELEMENT
ECO	48°C 60°C NA
STANDARD	55°C 60°C NA
HYBRID	55°C 60°C 65°C
HYBRID+	50°C 60°C 70°C
ELEMENT	60°C NA 70°C

COP | HEATING CAPACITY | LPH | RECOVERY TIME - 15°C to 55°C rise in stored water temperature

@ 0°C WET BULB TEMPERATURE	2.50 1500W 30L 8hr 40min
@ 7.5°C WET BULB TEMPERATURE	3.45 2100W 45L 5hr 55min
@ 15°C WET BULB TEMPERATURE	4.73 3000W 65L 4hr 05min
@ 20°C WET BULB TEMPERATURE	5.43 3500W 75L 3hr 35min
@ 25°C WET BULB TEMPERATURE	5.70 4000W 85L 3hr 15min

EFFICIENCY SAVINGS

ANNUAL POWER SAVING REPLACING ELECTRIC STORGE (MEDIUM HOT WATER LOAD) IN ZONE: 1 | 2 | 3 | 4 | 5

2500kW | 2450kW | 3050kW | 3240kW | 3185kW

STC RATING

STC RATING BY ZONE	1	2	3	4	5
ASSIGNED RATING	25	24	31	33	31
2023 DEEMED VALUES	20	20	24	26	26
2024 DEEMED VALUES	18	17	21	23	23
2025 DEEMED VALUES	15	15	18	19	19

VEECS RATING

VEECS RATING BY ZONE & REPLACEMENT TYPE	ZONE 4 = GAS/ELECTRIC	ZONE 5 = GAS/ELECTRIC
DOMESTIC	6 / 14	6 / 14

ESC RATING

ESC RATING BY ZONE & REPLACEMENT TYPE	ZONE 3 = GAS/ELECTRIC	ZONE 5 = GAS/ELECTRIC
DOMESTIC	18 / 39	18 / 40

REPS RATING

	113
--	-----

PARTS & CONSTRUCTION SCHEMATICS

4.1 DYNAMIC/X8 DIMENSIONS

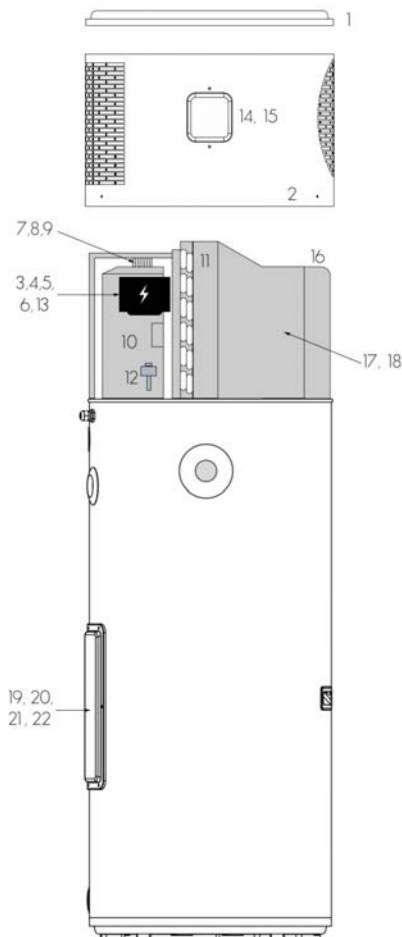
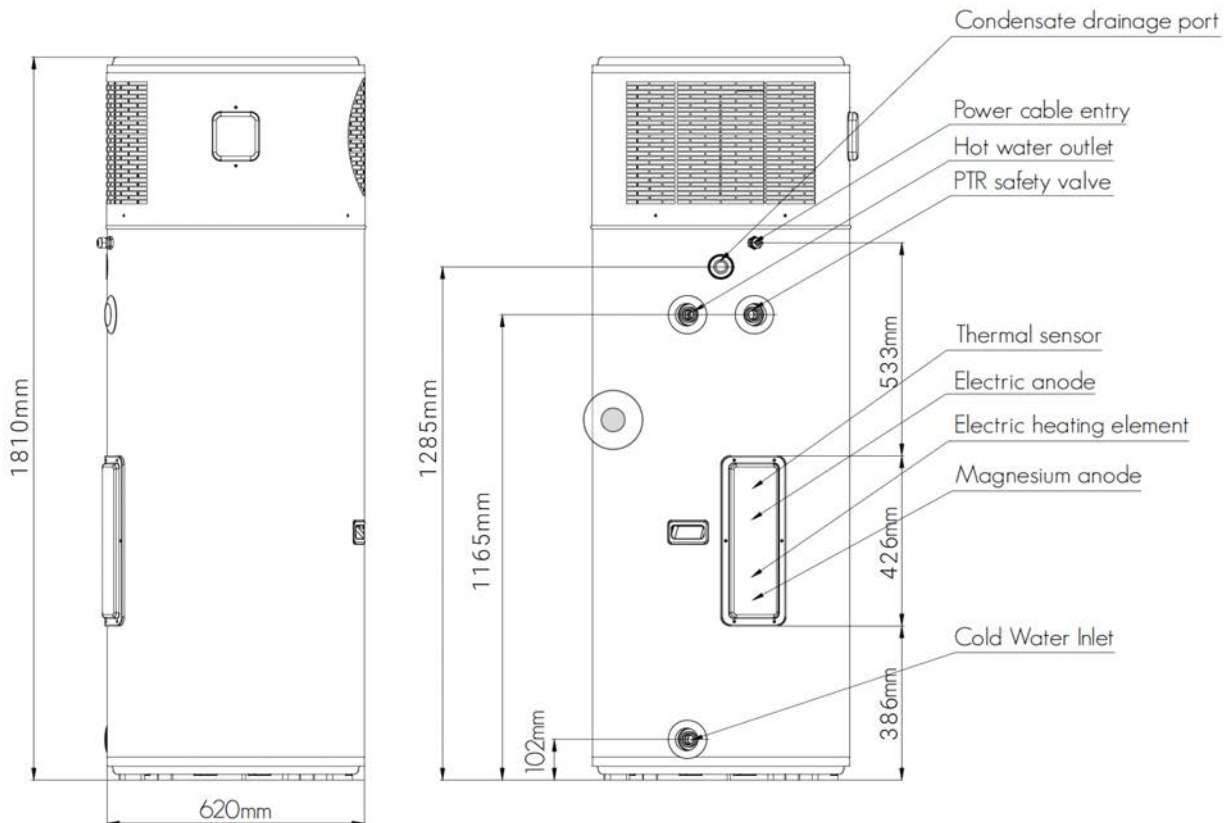

4.2 DYNAMIC/X8 PARTS SCHEMATICS

1.	TOP LID	12.	ELECTRONIC TX VALVE
2.	UPPER COVER	13.	5V SENSORS
3.	ELECTRONIC MAIN BOARD	14.	DISPLAY COVER
4.	ELECTRIC ANODE TRANSFORMER	15.	DISPLAY CONTROLLER
5.	FAN CAPACITOR	16.	FOAM FAN COVER
6.	AC TO DC TRANSFORMER	17.	FAN BLADE
7.	COMPRESSOR RUN CAPACITOR	18.	FAN MOTOR
8.	COMPRESSOR STARTER	19.	THERMAL SENSOR
9.	COMPRESSOR WIRING HARNESS	20.	ELECTRONIC ANODE
10.	COMPRESSOR	21.	ELECTRIC HEATER

INSTALLATION INSTRUCTIONS

All Hydrotherm heat pumps are designed for installation by a licensed plumber in accordance with standards set out in AS/NZS 3500.2 "National Plumbing and Drainage Code Hot Water Supply Systems - Acceptable Solutions".

5.1 DELIVERY

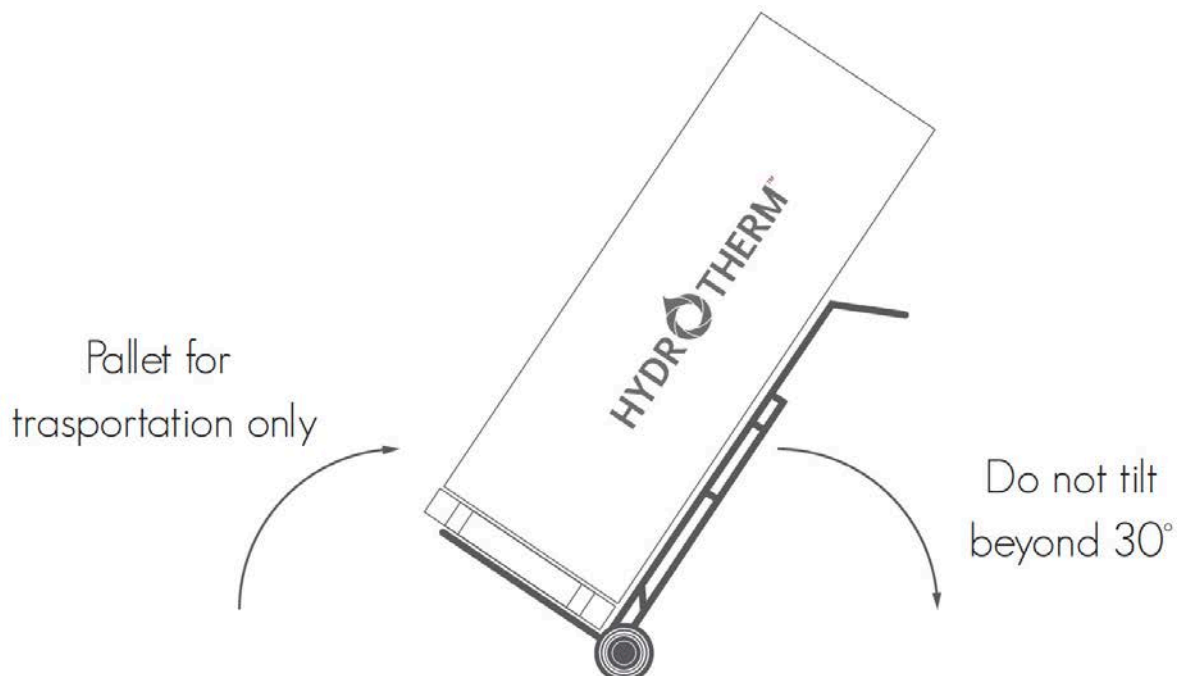

- Hydrotherm heat pumps must be stored and transported in a near vertical position at all times with a tilt ratio of no more than 30°. Transporting or storing the unit in a horizontal position will void warranty.
- The system should always be transported in its packaging.
- The weight of the package system is 137kg (118kg unpacked). The system must be handled by two people at all times to avoid unnecessary strain and damaged.
- Please note the outer casing of the unit is susceptible to denting and damage. Care and consideration should be taken into account when moving the unit as any marks caused by inappropriate handling are not deemed as defects and are not covered under warranty.



Important information regarding flammable materials.

- The appliance should not be stored or transported in an area with an ignition source.
- Do not pierce or burn the appliance.
- Be aware that the refrigerant may not cause an odour.
- Compliance with AS/NZS 5601 must be observed while storing the appliance.
- National and state regulations exist for the storage, transportation and handling of hazardous goods including flammable gasses.
- The maximum number of and configuration of the equipment permitted to be transported or stored together will be determined by the appliance regulations.

5.2 BASE

The following should be observed when selecting a base for a DYANMIC/X8:

- The unit should be installed on a concrete plinth or stable structure capable of sustaining weights in excess of 400kg. The supporting structure must not shift over time (due to water drainage etc.). A concrete base of at least 50mm thick or a well-seasoned hardwood slat at least 25mm is required. If a concrete base paver is being used, a minimum dimension of 600mm x 600mm is required.
- Please ensure that all four feet are supported by the base being used otherwise warranties maybe voided.
- Proper drainage should be observed for any overflow in accordance with AS/NZS 3500.2. & local standards.
- When installed the Hydrotherm unit must be completely vertical and level as to ensure that condensate can be properly drained. If the system is installed at a level with a tilt of more than 3 degrees, warranties may be voided.
- If property damage can occur due to water leakage, a safe tray (overflow tray) must be installed.

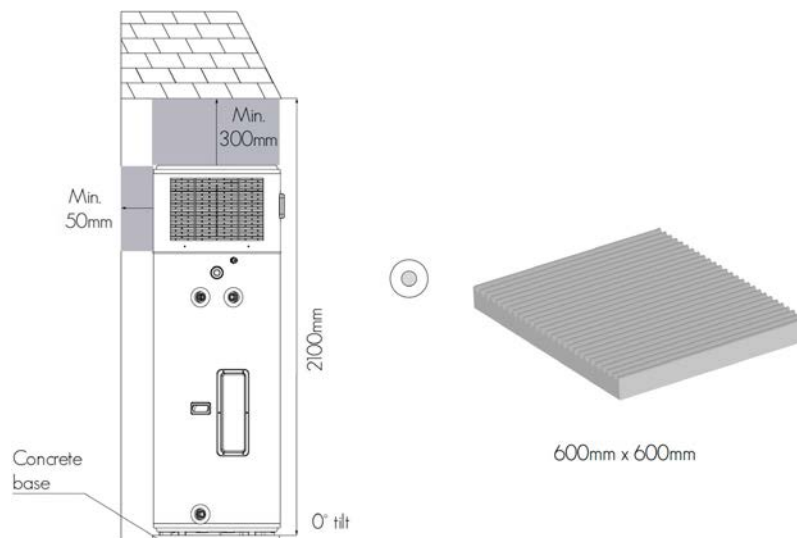
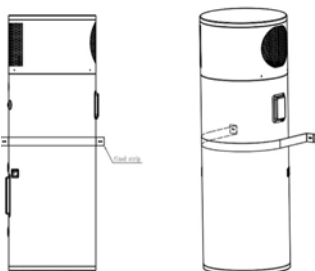

Figure 1: Side profile installation requirements and an example concrete base.



Warning about possible dangers.

If the product is installed in a location where there is a possibility of frost, then all precautions must be taken to ensure all pipework is sufficiently insulated.



The system should be permanently fixed to avoid tilting and movement beyond 15°. To achieve this, a 25 x 1mm stainless steel strap should be fastened around the centre of the cylinder and securely attached to the framing with a tension device, which will keep the straps in place.

5.3 AIRFLOW

- This unit requires a continuous supply of air to operate efficiently.
- Avoid installation in areas where falling debris such as leaves is prevalent, as this may result in air vents being blocked or the unit being damaged.
- Avoid placing the system in locations with multiple walls or structures (See Figure 1 & 2). Always maintain optimum perimeter from all structures.
- If installed under fixtures or home eaves, there must be a minimum 300mm clearance between the top of the unit, 600mm on the right-hand side of the system (when facing unit) and 150mm on the left-hand side of the system (when facing system) (see section 2.3 AIR FLOW).
- Hydrotherm must be installed a minimum of 50mm off your home's wall so that the entire unit can be accessed during any servicing work as well as to prevent circulation of cold air (see section 2.3 AIR FLOW). If the system cannot be properly serviced due to the system being installed outside of these specifications, the owner will be liable for the associate plumbing costs of draining and moving the system.
- The system should be installed so that the control interface is accessible to users and that there is clear access to the electrical panel at the back of the system.

If incorrect installation has occurred, warranties may be void or charges may be required to ensure that the system is compliant and/or serviceable.

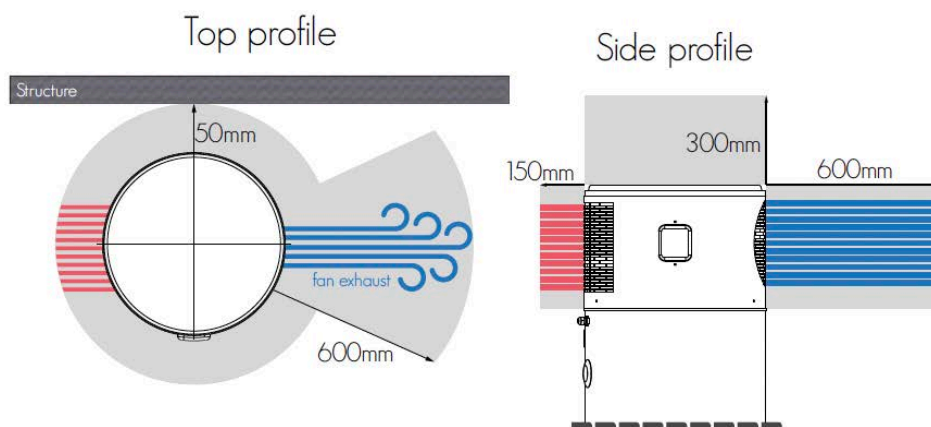

Figure 2: Front profile of DYNAMIC/X8 installation requirements.



Important information regarding flammable materials.

- The systems are designed for external installation with a minimum of 20m³ of unobstructed space surrounding the unit. If used indoors, the appliance must be placed, operated, and stored in a room with a floor area of at least 47m² and any required ventilation openings clear of obstruction
- Ensure the location complies with the Requirements with the regards to the heat pump containing a flammable refrigerant
- Ensure the electrical access point and display panel should always be accessible.

5.3 NOISE CONSIDERATIONS

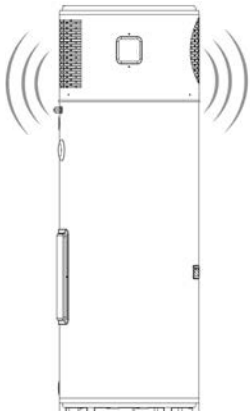

DYNAMIC/X8 operation noise has been rated against ISO 3745:2012 for following levels:

- **SOUND PRESSURE LEVEL = 42 Db(A)**
- **SOUND POWER LEVEL = 61 Db(A)**

Test conditions for readings are equivalent to 1.65m from system. Operating sound levels may vary based on environmental conditions such as fences/walls or depending on stage of heat cycle.



i To optimise system efficiency & limit disturbances, please set the system to **TIMER Mode** and use the built-in timers to run the system during the day. The factory setting of **TIMER Mode** limits operating time between 09:00 and 18:00, complying with EPA-prohibited operating hours.

- Do not install less than 3 metres from a neighbour's window or door (aside from garage door or shed).
- It is highly recommended that the system be programmed to run when noise is not objectionable, for example between 9am and 6pm, or that the system be located away from bedrooms.
- If you are experiencing noise issues with your Hydrotherm system, please contact Hydrotherm directly. There are means to mitigate the sound produced when the system is operational.

HEAT PUMP - OPERATING PRINCIPLE

The operation of an electric heat pump is very similar to a refrigerator, but in reverse. A heat pump operates by transferring heat from the ambient outside air into the water. Electricity is just used to operate the system, but not to directly heat the water. Because of this energy consumption is significantly reduced as compared to an electric element hot water system. The warmer the climate in which the heat pump is installed, the more efficient the heat pump system will be at heating water.

The heat pump unit includes highly efficient micro-channel heat exchanger wrapped around the inner cylinder for thermal conductivity. A temperature sensor in the tank is used to control the heat pump operation to achieve suitable tank temperature.

During the occasional times when the ambient weather conditions aren't suitable for the heat pump to operate, the electric element will provide heating to ensure a supply of hot water.

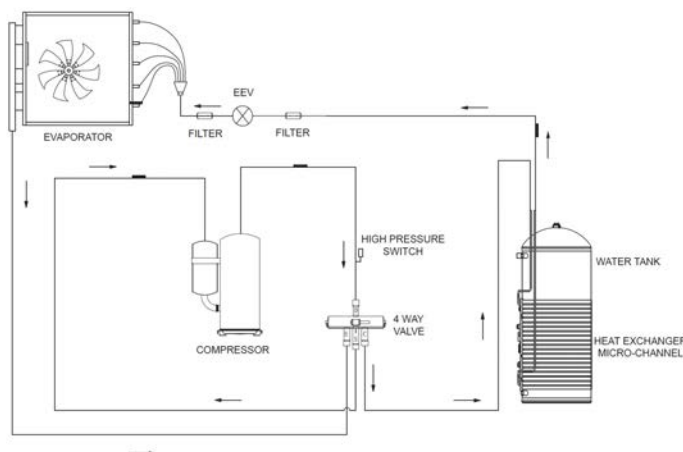

PLUMBING SCHEMATICS

7.1 DYNAMIC/X8 CONNECTION DIMENSIONS AND COMPONENTS

i The following instructions and schematics have taken into account standards AS4324, AS4020, AS1056.1, AS/NZS2712, AS/NZ3350.240/30/30.2, AS3498 and represents an optimum installation procedure for this unit however when installing please ensure minimum requirements are met for all state & local councils.

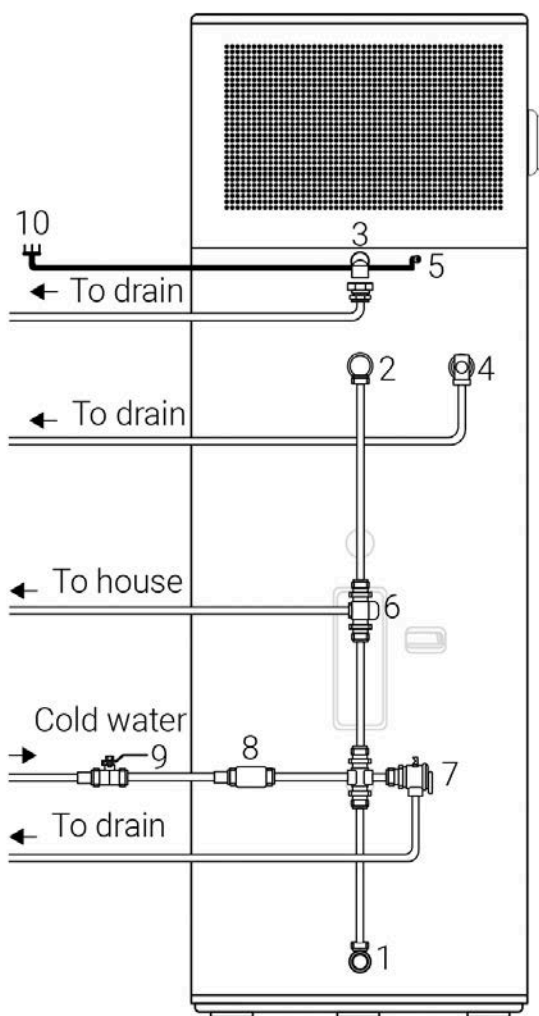

- 1 Cold Water supply outlet**
(G 3/4" female thread)
- 2 Hot Water Outlet**
(G 3/4" female thread)
- 3 Condensing drainage Elbow & Hose**
(supplied with system)
- 4 PTR Relief Valve**
(supplied with system)
- 5 Electrical Cable / Plug**
- 6 Tempering Valve**
(high performance recommended)
- 7 Expansion Control Valve (ECV)**
(if required by council 700kPa)
- 8 Pressure Reduction Valve**
(if required 500kPa)
- 9 Non-return/Isolation Valve**
- 10 Isolation Switch / G.P.O**

The electrical connection to this product must be via a 16A RCD/MCB or RCBO with a test button function.

i The product must be connected to a mains water supply with a supply pressure of no less than 150kPa and no more than 500kPa (if inlet pressure exceeds 500kPa a pressure reduction valve is required).

i This product is designed to be connected permanently to mains water using copper piping. The use of flexible hose sets or other types of connections is not approved.

PLUMBING INSTALLATION

8.1 PLUMBING CONNECTIONS

8.1.1 Cold water supply outlet

- The cold water supply connection is a G 3/4" female thread.
- The cold water supply should be connected to G 3/4" socket.
- The cold water supply outlet can also act as a drainage point for emptying the system.

8.1.2 Hot water connection

- The hot water supply connection is a G 3/4" female thread.
- The hot water supply should be connected to G 3/4" socket.
- To ensure thermal efficiency all hot water lines and connections must be insulated with a minimum 13mm closed cell insulation.
- All hot water supply parts must be constructed from copper. If using pipe of other material please refer to local authorities for further instructions.

i The hot and cold water inlets are fitted with plastic dielectric nipples to prevent the accumulation of dead water or debris in the threads. These nipples must not be removed and should be installed on both the hot water outlets.



8.1.3 Condensate Drain

- The process of heat extraction from the atmosphere through evaporator coils results in the production of water in the form of condensation. More humid environments will produce higher rates of condensation.
- To collect this water by-product a Condensate Tray is located on top of the water storage tank. Overflow from this tray runs out through the Condensate Drain.
- The system comes with a pre-installed condensate drain connection elbow. Drainage of condensate from elbow to nearest storm water to be done by the collection into an open dish and drained via copper piping.
- If not drained properly, the condensate line will attract termites as well produce algae and moss growth.
- The Condensate line should be free of kinks and as and as the water is gravity fed, should only be running down to ensure the free flow of water.

i A PVC tube is supplied which can be used to bridge the air gap between the condensate elbow and dishes. The PVC tube can also be used to drain condensate directly from condensate elbow to a storm water drainage point, if copper drainage is not required by local council regulations.

⚠ Warning about possible dangers.

Connecting any pressurised line to the condensate without an gap will void warranties.

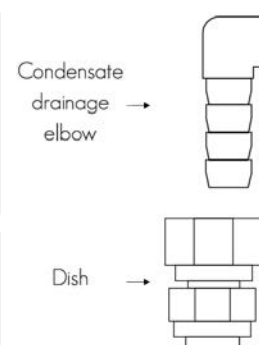

8.1.4 Pressure & Temperature Relief (PTR) Valve

- The system is supplied with a loose PTR valve appropriate to the pressure rating of the water heater tank. If the PTR valve is not present please contact your supplier. The valve Rated capacity: 850kPa;10kW; Set temperature: 93-99°C.
- The supplied PTR valve must be installed at Point 4 in section 7.1 DYNAMIC/X8 Connection Dimensions and Components under the socket marked "RELIEF VALVE".
- The relief valve must be installed so that the drain line is facing downwards at all times with the discharge point remaining open to the atmosphere.



Warning about possible dangers.

NEVER block the outlet of the PTR valve or its drain line for any reason. The easing gear **MUST** be operated at least every **6 months** to remove lime deposits and verify that it is not blocked. Failure to do this may result in the water heater failing. If the valve does not discharge water when the easing gear lever is opened, or does not seal again when the easing gear is closed, attendance by an authorised person **MUST** be arranged without delay. The PTR valve is not serviceable.

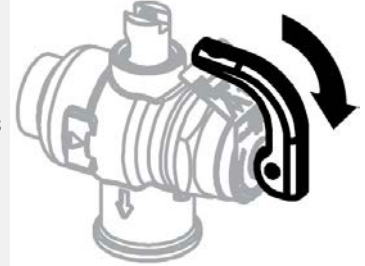

It is normal and desirable that this valve allows a small quantity of water to be discharged during the heating cycle. If it discharges more than a bucket of water during a 24 hour period or discharges continuously there may be another problem.

If the valve dribbles continuously, try easing the valve gear for a few seconds as described above. This may dislodge any foreign matter and alleviate the problem.

If the valve discharges at high flows, especially at night, it may be as a result of the water pressure exceeding the design pressure of the water heater. Ask your installer to fit a Pressure Limiting Valve (PLV).



Warning about possible dangers.

NEVER replace the PTR valve with one which has a higher pressure rating than is specified.

8.1.5 Tempering Valve

- DYNAMIC/X8 systems are automatically programmed to produce hot water in excess of 50°C. As such, in accordance with AS/NZS3500, it is mandatory that a Tempering Valve is installed.
- We recommend a high performance or solar rated tempering valve is used to ensure a more accurate hot water delivery temperature.
- Your old hot water system might not have had a tempering valve installed before and therefore you will notice a change in the temperature of the hot water. This is normal and required under new legislation. Should you have any concerns, please contact your installer.

8.1.6 Expansion Control Valve

- Please observe local requirements with regards to the installation of an ECV (optional in most councils).
- When installing an ECV, ensure that the connecting pipe has a diameter no greater than that of the safety valve. The ECV should be rated at no more than 700kPa
- Ensure the drain is sized to allow for water runoff, even in incidents where the safety valve has been fully opened. The drain outlet must remain open to the atmosphere at all times and must not have a closing.

8.1.7 Pressure Reducing Valve

- This water heater is supplied with a PTR valve rated at 850kPa and is designed for direct-connection to mains water supply with a pressure not exceeding this rating.
- Should main pressure fluctuate above this rating, a pressure limiting device (AS1357) should be connected at Point 8 in section in section 7.1 DYNAMIC/X8 Connection Dimensions and Components under the socket marked “PRESSURE REDUCTION VALVE”.
- The relief valve must be installed so that the drain line is facing downwards at all times with the discharge point remaining open to the atmosphere.

8.1.8 Non-return/Isolating Valve

- It is compulsory that a non-returning/isolation valve is installed directly into the cold-water supply line feeding the system. This will allow the hot water system to be isolated from the rest of the homes water supply, making servicing, draining and replacing the unit easy. A hose-set must not be used to connect the system to water supply.
- The non-return/isolation valve can be combined with a PRV valve to form a duo valve.

8.1.9 Water Quality

- Bad quality water will produce more scale and sand, so this kind of water should be filtered.
- The water quality should be analysed before system running, to measure the PH value, conductivity, Chloride ion concentration and sulphate ion concentration.
- The acceptable water quality standard is showed as below table.

PH	Hardness	Conductivity	Sulphate	Chlorine	Ammonia	Silicon	Iron	Ca
7 - 8.5	< 50ppm	<200µV/cm(25°C)	None	< 50ppm	None	< 50ppm	< 0.3ppm	< 50ppm



Filling the system

- Once the Hydrotherm has been connected in accordance to Section 7.0 and 8.0 of this handbook, the tank can be filled and pressurized.
- Open the non-return valve on the cold-water inlet to begin filling the system with water. At the same time, ensure at least one hot water tap is open inside the property. While the system begins filling with water you will hear air being expelled from the open hot water tap. This is called “bleeding the system” and it ensures that no air pockets remain. Once water begins running out of the hot water tap, the system is completely bled and you can then turn the tap off.
- Always ensure that the tank is completely full before connecting and turning on the electricity supply.

PLUMBING MAINTENANCE

9.1 OPERATING P.T.R VALVE - (6 MONTH INTERVALS)

It is recommended to operate the PTR valve periodically to ensure water flows freely. If water doesn't flow freely, the PTR valve will need to be replaced.

Locate the PTR valve on the left hand side of the unit.

- Carefully release the valve using the lever & release some water from the tank.

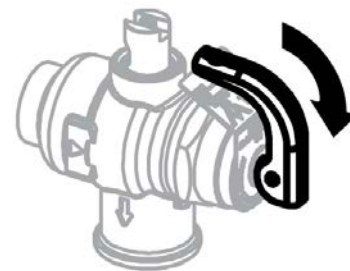

NOTE: WATER EXPELLED MAY BE EXTREMELY HOT.

- If water flows freely the PTR appears to still be in a suitable working condition.
- If water flows freely the PTR appears to still be in a suitable working condition.
- If the PTR valve needs replacing, please contact your plumber or our service team for further assistance.

9.2 CHECK BACKUP ANODE & REPLACING IF REQUIRED - (5 YEAR INTERVALS)

The system has a backup magnesium anode that protects the inner lining of your hot water tank if power is cut to primary impressed current anode. When the anode become degraded the level of protection is diminished. It is recommended that anode is periodically checked for its level of degradation and gets replaced if required.

- Turn off the power and turn off the cold water inlet valve.
- Open a hot water tap and decrease the pressure of the inner container.
- Open the drain port and drain remaining water completely in the release about 20L water.
- Remove the side cover by removing the screws, locate the anode position behind the cover.
- Unscrew the anode using 3/4" socket and pull out- Check for degradation.
- If still in suitable condition, refit ensuring an effective seal
- If anode is in an unsuitable condition, replace with a new one, ensuring an effective seal.
- Reopen the cold water inlet valve.
- Open a hot water tap until hot water flows out, then turn off the hot water tap.
- Turn on the power to restart the unit, now the unit can be used as normal.

9.3 DRAIN THE INNER TANK - (5 YEAR INTERVALS)

It is recommended to clean the inner tank and electric heating element regularly to maintain efficient performance.

- Turn off the power and turn off the cold water inlet valve.
- Close the cold water inlet valve & open a hot water tap.
- Use a flexible pipe to connect the drain port to a suitable sewage drain. (Note: The min. heat resistance of the drain pipe must not be less than 93°, if the drain pipe does not meet the requirement, please open the cold water inlet valve & open a hot water tap, until the temperature of the water is suitable for the drain pipe).
- Open the drain port of the water heater; drain out all the water in the inner tank. If it is needed, use water to wash the inner tank several times to clear the deposits.
- Close the drain port, re-fill the inner tank with water, and turn the power back on.

ELECTRICAL SCHEMATICS & CONNECTIONS

10.1 ELECTRICAL SCHEMATIC

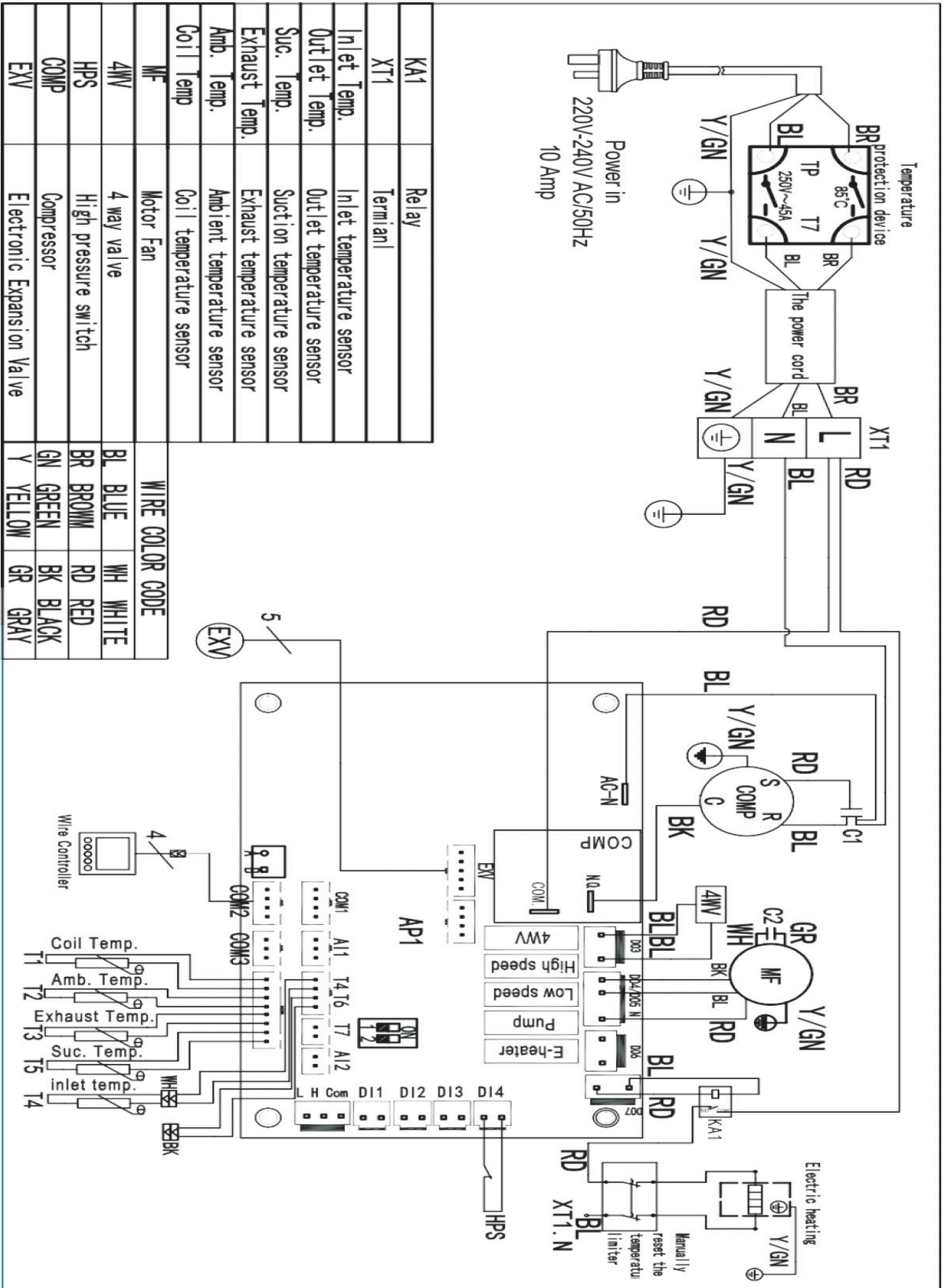

10.2 PRE-CONNECTION & REGULATIONS

- Before any work can commence, ensure that the heater is isolated from the power supply at the control panel.
- The DYNAMIC/X8 heat pump is designed for permanent connection to either a Continuous-Tariff (single phase 240V AC supply) or a Shoulder Tariff (single phase 240V AC supply).
- When connecting the unit, electrical work must comply with the local supply authority regulation as well as AS3000.
- The power rating of the unit is set at 10 amps as such the mains power supplying the unit must have a 10 amp minimum circuit breaker fitted.
- To gain access the electrician may remove the four connecting screws and raise the cover upwards off the unit base exposing electrical works (see section 7.2 DYNAMIC X8 Connection Dimensions And Components).
- Note this device is fitted with an over-temperature control cut-out. Under no circumstances must the water heater be in operation without this safety device connected to the circuit. Re-setting and replacement of this device must only be carried out by a qualified electrical contractor.
- (AS/NZS 60335-1 Clause 7.12.2): disconnection must be incorporated in the fixed wiring in accordance with the wiring rules.
- FUSE: 250V, T3.15A



Electrical warning

This appliance shall be installed in accordance with National wiring regulations AS.3000.

The power supply to the heat pump module **MUST NOT** be activated until the system is filled with water.

The premises wiring to the heater **MUST** be capable of withstanding the appliance load. Refer to specification table for load details.

All electrical connections and wiring **MUST** be installed, maintained and removed by authorised persons in accordance with AS/NZS 3000, and all other relevant local regulations and municipal building codes including OH&S requirements.

The Heat Pump is fitted with a power cord & 10Amp plug, it **MUST** connect to an independent, fused, AC 240V 50 Hz power supply with an isolating switch installed at the switch board, which shall effectively isolate all active supply conductors from the circuit and a means for disconnection **MUST** be incorporated in the fixed wiring in accordance with the wiring rules.

A Residual Current Circuit Breaker is recommended for the power supply to this appliance (this may be a mandatory requirements in some states or jurisdictions).

If the supply cord is damaged, it must be replaced by either the manufacturer, a service agent or similarly qualified person in order to avoid a hazard.

10.3 CONNECTING TO POWER SUPPLY

The DYNAMIC/X8 system is supplied with a 3 point earthed plug and may be run off a power socket where such connection is compliant with National wiring regulations AS.3000 and/or such requirements as stipulated by local authorising bodies.

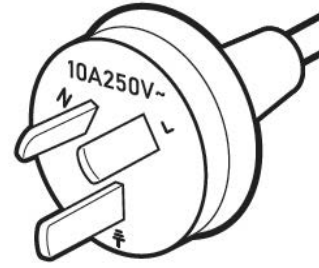

Should permanent connection to power supply be required by National wiring regulations AS.3000 and/or local authorising bodies. A qualified electrician should remove the unit's plug and utilise the power supply cord to wire the system into a junction box with isolation switch.

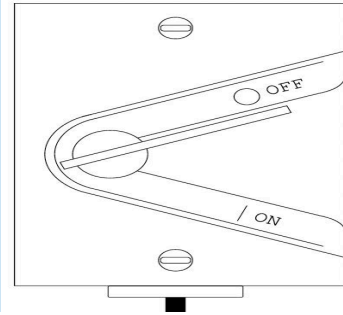

Electrical recommendations

To ensure the heat pump will not overload the power supply and to provide optimum safety running conditions, electrical connection to this product is recommended as an isolated circuit rated at 20A RCD/MCB or RCBO with a test button function.

10.4 ELECTRICAL TESTING

When conducting an insulation test using a Megger on this appliance, observe the following:

Insulation test results of between 100 kΩ and 660 kΩ are normal for this appliance. In accordance with AS/NZS 3000 an insulation test with a result less than 1 MΩ is permitted where the appliance is approved to a Standard applicable to that class of appliance.

This appliance is categorised and certified as a 'stationary Class 1 motor operated appliance' and therefore satisfies the requirements of AS/NZS 60335.2.40 for leakage current and electric strength. As such, this appliance complies with the insulation resistance requirements of AS/NZS 3000.



Electrical warnings

This appliance contains electronic components, when performing insulation tests (500 Volts) this **MUST ONLY** be conducted across active terminal to earth and then across the neutral terminal to earth. Tests between the active to neutral terminals **MUST NOT** be performed as this **WILL** damage the electronic components.



DANGER warnings

The operation of the thermal cut-out indicates a possibly dangerous situation. Do not reset the thermal cut-out until the water heater has been serviced by a qualified person..

COMMISSIONING THE SYSTEM

11.1 PRE-START PROCEDURES & CHECKS

- Once both the electrical and plumbing connections have been completed by qualified trades person, the system is now ready for operation.
- Before turning the system on it is essential that you ensure the heat pump storage tank is full and the unit thoroughly flushed.
- Air pockets must be bled from the system via a hot water tap. Do not use the PTR valve alone to bleed the system.
- Ensure the device is resting on a smooth flat concrete plinth and that a condensate drain is installed from the condensate port to an appropriate drainage point.
- Ensure that your plumber has insulated with high temperature closed cell insulation to prevent heat loss.
- Ensure that air can flow freely around the intake vents.

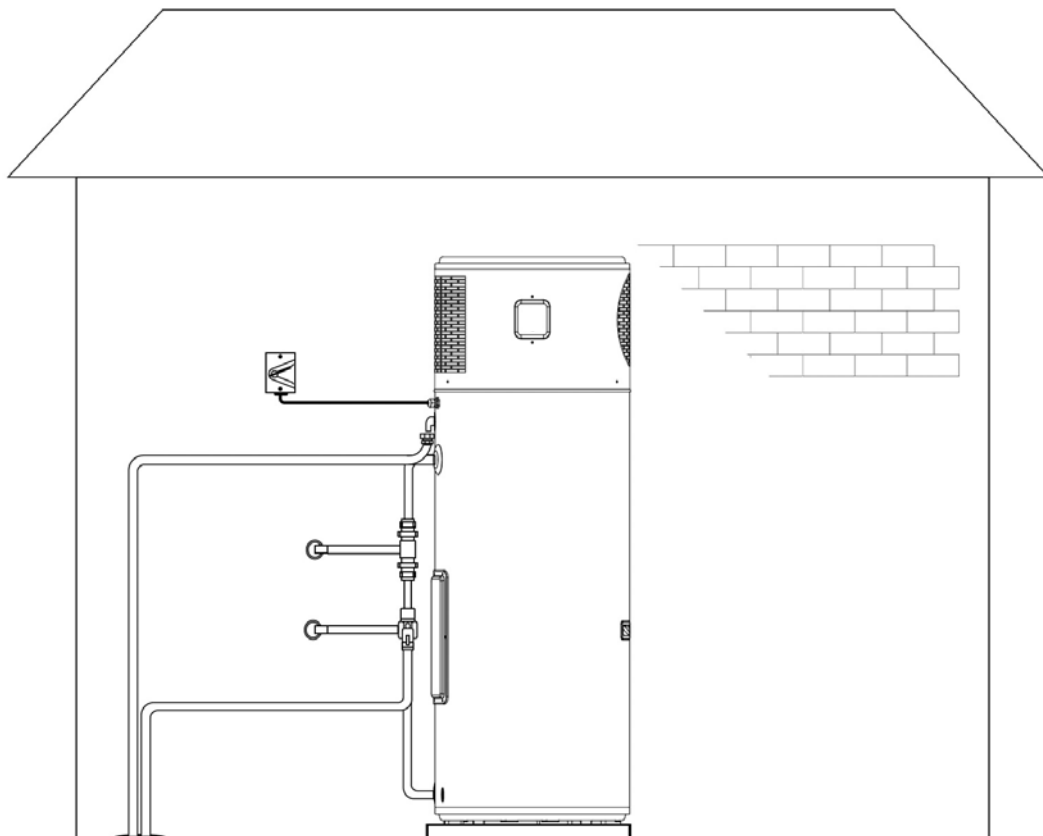

PRE-CHECK WARNINGS

This appliance is not intended for use by persons (including children) with reduced physical sensory or mental capabilities, or lack of experience and knowledge, unless they have been given supervision or instruction concerning use of the appliance by a person responsible for their safety. Children should be supervised to ensure that they do not play with the appliance. The appliance shall be installed in accordance with national wiring regulations.

11.2 PRE-START PROCEDURES & CHECKS

- The DYNAMIC/X8 system is level.
- The DYNAMIC/X8 system is installed on a concrete plinth or stable capable of sustaining weights in excess of 400kg structure
- A minimum distance of 300mm is present above the DYNAMIC/X8 system, to allow the lid to be removed for maintenance (see section 5.3 Air Flow).
- A minimum distance of 600mm is present on the fan discharge side and 150mm on
- A minimum distance of 50mm is present between the exterior of the tank and wall for
- The condensate drainage elbow has only been hand tightened (see section 8.0 Plumbing Installation).
- The condensate drainage elbow is free flowing (i.e. gravity fed) and not directly connected to the PTR or any other line (see section 8.0 Plumbing Installation).
- The unit is connected to either a Continuous 24 hour supply or a Shoulder Tariff Minimum 16 hour supply. (not connected to the Off-peak 8-10 hour supply).
- The plumber has explained the purpose of the tempering valve.

Once the system has been installed, the installing plumber should sign below to ensure that all procedures have been complied to otherwise warranties may be voided.

Installer's Full Name:

Date:

Installer's Signature:

Once you have carried out all these checks, you are ready to switch on your DYNAMIC/X8.

OPERATION PANEL INSTRUCTIONS

12.1 ACCESSING THE DISPLAY PANEL

The system's front metal cover protects the display panel from damage.

TO ACCESS THE DISPLAY PANEL:

1. Undo the hand screws located at the top and bottom of the display cover by turning them clockwise. Place the hand screws somewhere safely.
2. Slowly remove the display cover and place somewhere safe.

TO REATTACH THE SCREEN COVER:

1. Place the display cover over the display screen, ensuring the hand screw holes are aligned.
2. Replace the hand screws, and using your hands only, tighten the hand screws by rotating clockwise. Ensure a seal is formed from the display cover over the panel.

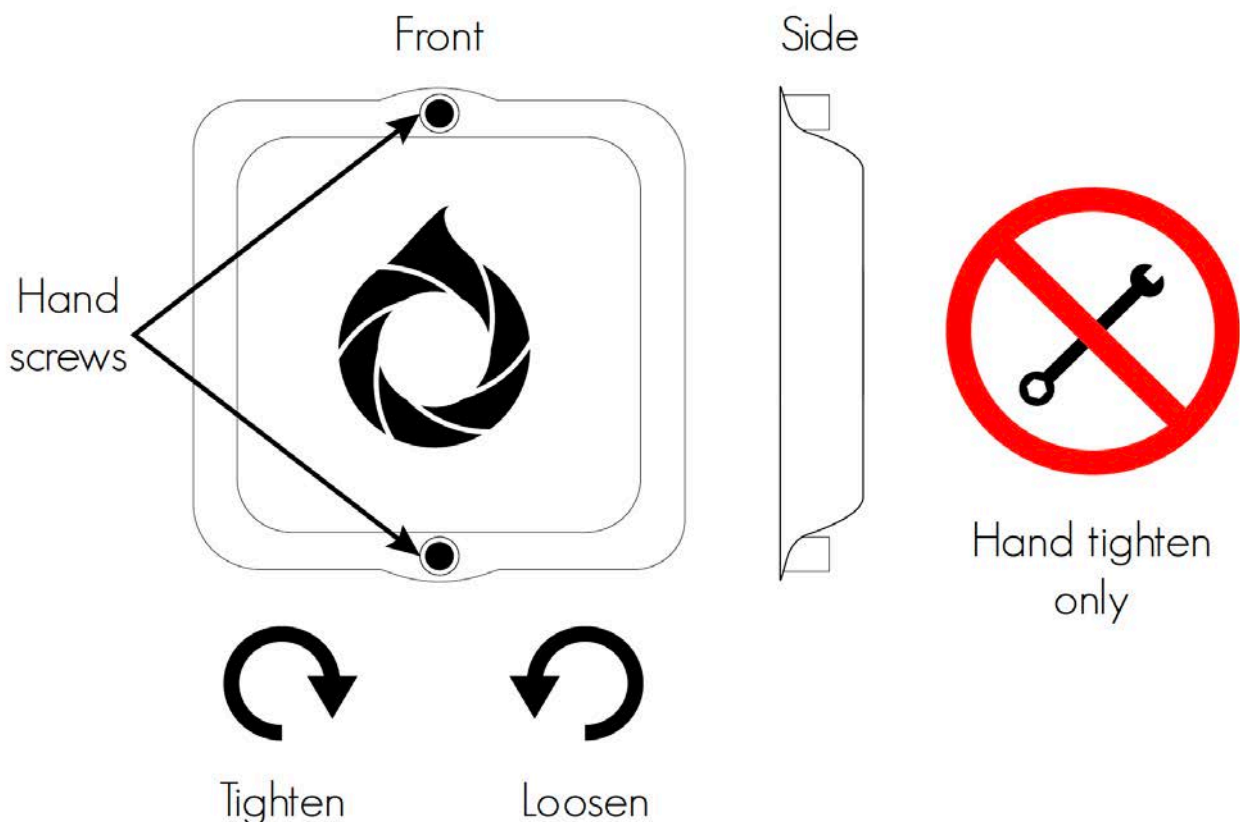

Always ensure that the screen panel has been replaced after accessing the control screen. If the screen panel has not been replaced, the screen may become damaged from the elements.

12.2 TURNING THE SYSTEM ON

When you first power your new system, you will need to turn the system on. The system won't need to be turned on each time it heats, only the first time the unit is powered or if the unit has been turned off.

1. PRESS THE ON/OFF BUTTON.

The "SHOWER" symbol will appear on the screen with the current mode underneath.



If the system is just showing the tank water temperature (dark mode), press anywhere on the screen to access the main screen.

12.3 SETTING DATE & TIME

In order for your DYNAMIC/X8's timers to work properly, the internal clock needs to be set correctly.

1. PRESS THE "SETTING" BUTTON.



2. PRESS "DATE & TIME"

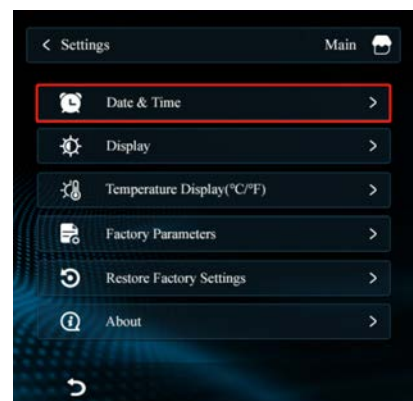

3. ADJUST DATE & TIME.

Using the touch screen, press on the value and change it accordingly. Note that the time is displayed in a 24-hour format.

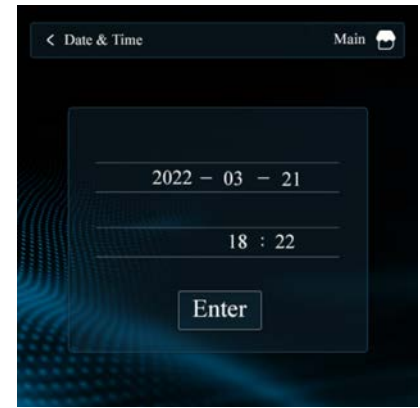

The heat pump will keep the time if the system has no power, using the in-built battery. However, if the system is not powered for a long period of time the clock may not be set correctly when the system has been turned on again.

12.4 SETTING HEATING TIMER WINDOWS

USING THE IN-BUILT TIMERS IS RECOMMENDED FOR THE FOLLOWING REASONS:

1. The in-built timers can be used to fully utilize a Solar PV system
2. Heat pumps work considerably more efficiently during daylight hours when ambient air temperatures are at their highest.
3. Running the heat pump during the day will minimise noise disturbance.

THE FACTORS TO CONSIDER WHEN USING TIMERS ARE:

1. TARIFFS - Certain tariffs will not coincide with the default timer periods and therefore the system may not have enough time to recover.
2. HOT WATER USAGE - Be aware of your peak usage and recovery times.
3. TEMPERATURE & CLIMATES - Ensure you allow enough time for the unit to heat in varying temperatures and humidity.
4. MULTIPLE HEATING WINDOWS – If setting multiple heating windows each window should be a minimum **3 HOURS**. Setting shorter windows will impact performance and longterm durability.
5. LEGIONELLA CONTROL – The system should have a minimum daily time to heat of at least **6 HOURS**. This should ensure that a minimum 45% of stored water will reach a temperature of 60°C daily.
6. TRIGGER TEMPERATURES – If the system fails to reach the set temperature during a heating window, it will not begin reheating until the tank water temperature reaches the trigger point based on the selected mode.



We recommend running the single timer window (08:00 – 18:00) which comes pre-set as a factory default and only needs to be turned on with adjustment. This period is typically the hottest part of the day and when energy produced from Solar PV is at its highest.

1. PRESS THE "FUNCTION" BUTTON



2. PRESS THE "TIMING FUNCTIONS" ICON



3. SELECT TIMER

Select any of the three timers to adjust the ON & OFF timer windows.

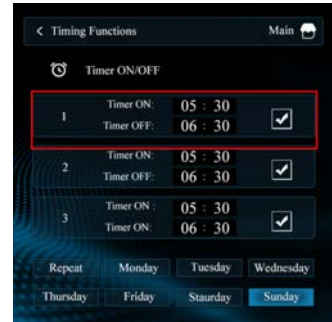

4. SET/ADJUST TIMER.

Adjust the Start and End periods of the timers, simply press the value you would like to change and adjust accordingly. Click ENTER to lock in timer.

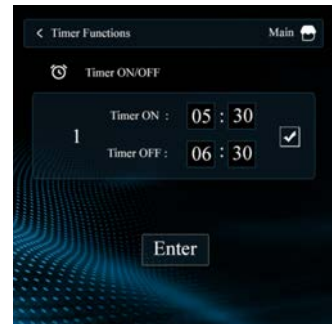

5. TURN TIMERS ON/OFF.

Turn ON any timer by ticking the box. The timer symbol will now appear on the main screen indicating that the system is now using a timer.

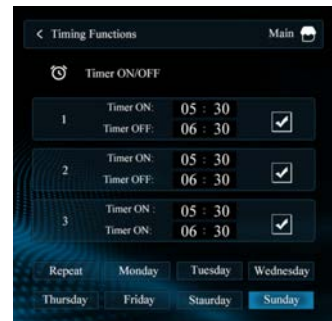

For further information about setting timers, please call directly on 1300 769 904 or visit the Hydrotherm website www.hydrothermhotwatersystems.com.au

12.5 HEATING MODES

The heat pump controller offers five smart modes, allowing customisation for any home's specific requirements. EACH MODE HAS UNIQUE:

- SET TEMPERATURE** (Water temperature at end of heating cycle)
- TRIGGER TEMPERATURE** (Water temperature that starts a new heating cycle)
- HEATPUMP TEMPERATURE** (Water temperature heated to by heat pump during cycle)
- ELEMENT TEMPERATURE** (Water temperature heated to by element during cycle)
- ENERGY** (kW used for one heat cycle from 15°C Start to mode SET TEMP @ 15°C ambient)

	SET	TRIGGER	HEATPUMP	ELEMENT	ENERGY
ECO (Default Setting)	60°C	48°C	60°C	NONE	4.50kW
The heat pump is solely responsible for heating and does not rely on the element for any input. This mode of operation is highly recommended for households with Small or Medium demand, who do not wish to set timers or have the system run on a controlled tariff.					
STANDARD	60°C	48°C	60°C	NONE	4.50kW
To maximise the usage of your home solar PV or take advantage of specific time-of-use tariff periods, it can be beneficial to switch your system to STANDARD mode instead of the default ECO mode. This is because STANDARD mode lowers the trigger temperature from 48°C to 55°C. This reduces the impact of tank stratification, making it more likely for the system to engage a heat cycle in the appropriate timer window. By doing so, you can optimise the usage of your system and save money on your energy bills.					
HYBRID	65°C	55°C	60°C	65°C	5.55kW
This mode is ideal for households falling under the Small or Medium load profile, and who want to limit the heating system to a once-per-day cycle to make the most of Solar PV output or to synchronise with off-peak time of use tariffs. The higher temperature setting helps meet hot water demands when recovery windows are limited by timers. Although it consumes an additional 1.055kW, the cost of using solar or off-peak power is much lower compared to peak power, which makes up for the additional consumption cost.					
HYBRID+	70°C	50°C	60°C	70°C	6.60kW
Recommended for homes with medium to large usage that want to limit their heating to a once-per-day heating cycle. This is to take advantage of solar PV output or off-peak time-of-use tariffs. The higher set temperature helps meet demand when timers limit recovery windows. Although this mode consumes an additional 2.10kW of energy per cycle, it can be cost-effective compared to running other less energy intensive modes on a continuous power tariff.					
ELEMENT	70°C	60°C	NONE	70°C	11.60kW
This mode is as a temporary solution for the hot water supply in case an onsite service is needed. It can also be helpful for homes whose heat pump has reached the end of its life to provide hot water while considering replacement options. This can alleviate the time pressure often associated with hot water replacements and prevent decisions that could negatively affect the consumer.					

12.6 SELECTING A HEATING MODE

1. ACTIVATE MODE SELECT SCREEN.

Press mode icon to bring up the list of available modes.



2. SELECT MODE.

Click the mode you wish to select. Then click the BACK arrow to return to main screen.



3. MODE DISPLAY.

The selected mode will appear underneath the SHOWER symbol and the SET TEMPERATURE will update according to the mode pre-sets.



- Any timers you set on the system will operate across all modes.
- The control parameters are designed to ensure that at least 45% of the stored water reaches 60°C daily to ensure compliance with legionella disinfection.

12.7 WI-FI CONFIGURATION

Homes are getting smarter, and so should your hot water system. Our heat pumps are Wifi enabled via the Tuya smart-home app. So you can control and monitor hot water from your phone or tablet.

DOWNLOAD THE WI-FI SETUP MANUAL

<https://www.hydrothermhotwatersystems.com.au/downloads/>



DOWNLOAD THE TYUA SMART APP

<https://www.tuya.com/product/app-management/all-in-one->



12.8 SYSTEM RUNNING STATE

The controller includes system diagnostics for owners to quickly check heat pump performance during a heating cycle. This allows remote technical support to diagnose potential issues and provide solutions without requiring onsite servicing.

TO ACCESS THE DIAGNOSTICS:

1. PRESS THE "QUERY" BUTTON



2. PRESS "SYSTEM PARAMETERS"

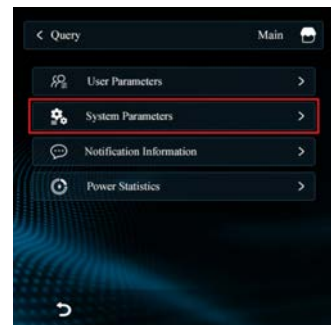

3. USE THE "ARROWS" TO CYCLE



DIAGNOSTICS LIST OF DISPLAYED PARAMETERS WHEN HEATING

- | | |
|---|--|
| 00. GAS/WATER CIRCULATION = 1 (GAS) | 12. 4-WAY VALVE (DEFROST) = 0 (OFF) / 1 (ON) |
| 1. HIGH PRESSURE SWITCH = 1 (OFF) | 13. HIGH SPEED FAN = 0 (OFF) / 1 (ON) |
| 2. LOW PRESSURE SWITCH = 0 (OFF) | 14. LOW SPEED FAN = 0 (OFF) / 1 (ON) |
| 3. WATER FLOW SWITCH = 0 (OFF) | 15. CIRCULATION PUMP = N/A |
| 4. EEV OPENING = 100 - 480 | 16. ELECTRIC ELEMENT = 0 (OFF) / 1 (ON) |
| 5. EVAPORATOR COIL = 5 - 15°C BELOW AMBIENT | 17. RUN TIME BEFORE DEFROST = (ACCUMULATED) |
| 6. AMBIENT TEMP = CURRENT AIR TEMPERATURE | 18. LINK SWITCH = 0 |
| 7. GAS SUCTION = 5 - 15°C BELOW AMBIENT | 19. PROGRAMME VERSION = 5 |
| 8. GAS EXHAUST = 10 - 20°C ABOVE WATER TEMP | 20. SWITCH 1 = 0 (PREVENTS ELEMENT & HEAT PUMP RUNNING TOGETHER) |
| 9. TANK TEMP = CURRENT WATER TEMPERATURE | 21. SWITCH 2 = 0 (PREVENTS ELEMENT & HEAT PUMP RUNNING TOGETHER) |
| 10. PIPE WATER TEMP = N/A | 22. POWER SUPPLY PHASE = 1 |
| 11. COMPRESSOR = 0 (OFF) / 1 (ON) | 23. COMPRESSOR CURRENT = CURRENT VOLTAGE) |

12.9 SYMBOLS & BUTTONS

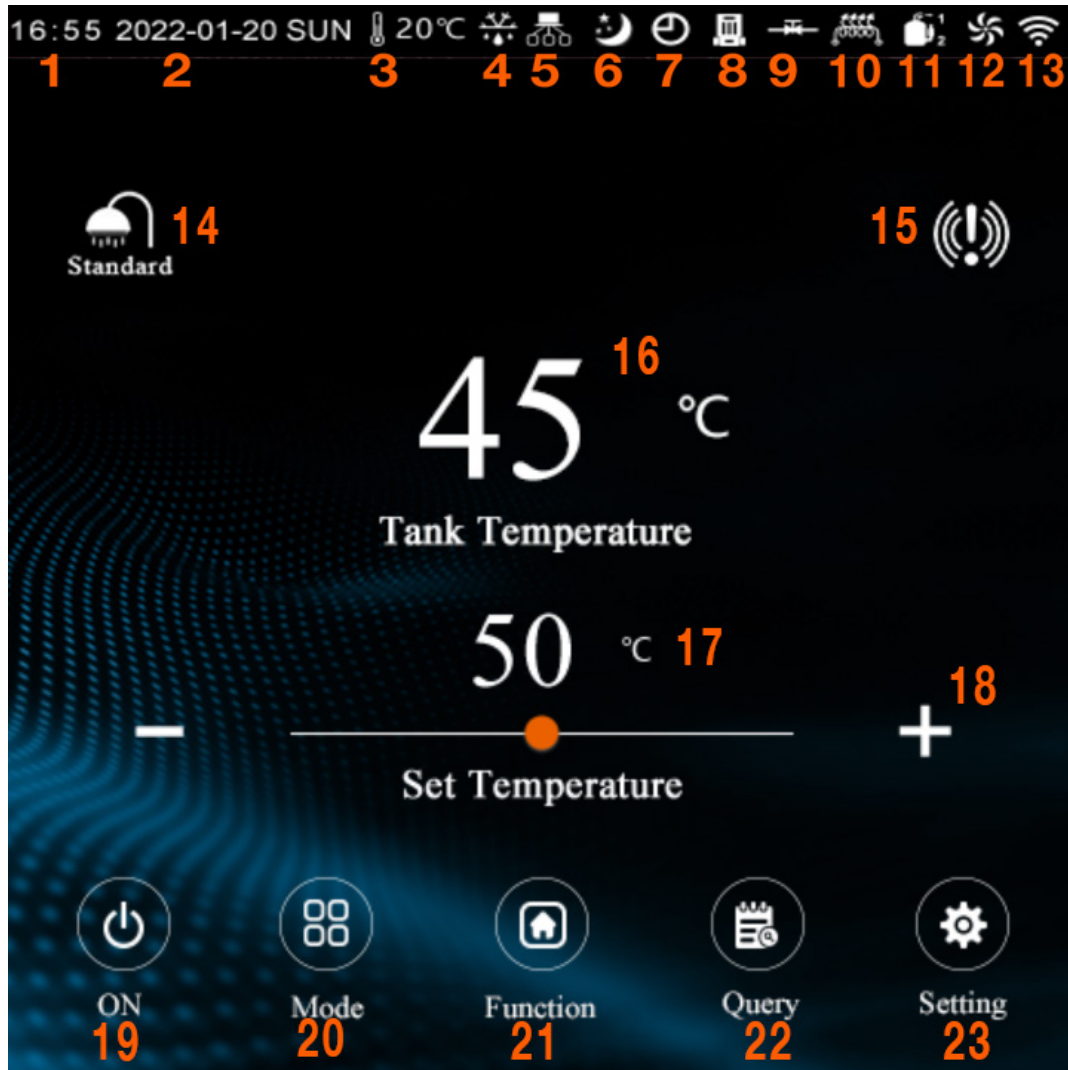

- | | |
|--|--|
| 1. CURRENT TIME | 13. WI-FI SYMBOL (LIT WI-FI IS CONNECTED) |
| 2. CURRENT DATE | 14. SHOWER SYMBOL (SYSTEM IS ON FOR HEATING) |
| 3. CURRENT AMBIENT TEMPERATURE | 15. ERROR SYMBOL (SYSTEM HAS A FAULT) |
| 4. DEFROST SYMBOL (LIT IF DEFROST IS ACTIVE) | 16. CURRENT WATER TEMPERATURE |
| 5. NETWORK SYMBOL (N/A) | 17. SET WATER TEMPERATURE |
| 6. SLEEP SYMBOL (N/A) | 18. SET TEMPERATURE ADJUSTMENT BUTTONS |
| 7. TIMER SYMBOL (LIT IF TIMERS ARE ACTIVE) | 19. SWITCH SYSTEM ON/OFF BUTTON |
| 8. WATER PUMP SYMBOL (N/A) | 20. MODE MENU BUTTON |
| 9. WATER FLOW SYMBOL (N/A) | 21. FUNCTION MENU BUTTON |
| 10. ELEMENT SYMBOL (LIT IF ELEMENT IS HEATING) | 22. QUERY MENU BUTTON |
| 11. COMPRESSOR SYMBOL (LIT COMPRESSOR IS ON) | 23. SETTING MENU BUTTON |
| 12. FAN SYMBOL (LIT FAN IS ON) | |

12.10 FAULTS & ERROR CODES

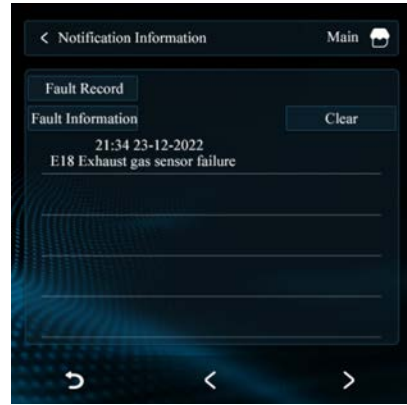

If the unit experiences a fault, the “FAULT ICON” will flash to indicate it. Clicking on this icon will take you to the real-time fault/fault record. This page can display up to 20 real-time faults and 50 historical faults. Once the fault has been resolved, the icon will disappear.

ERROR CODES

- E05** HIGH VOLTAGE PROTECTION
- E09** COMMUNICATION FAILURE
- E12** COMPRESSOR TEMP TO HIGH
- E14** WATER TEMP SENSOR FAILURE
- E16** EVAPORATOR TEMP SENSOR FAIL
- E18** COMPRESSOR TEMP SENSOR FAIL
- E21** AMBIENT TEMP SENSOR FAIL
- E29** SUCTION TEMP SENSOR FAIL



If a fault occurs please note down the error code and then call technical support 1300 769 904

12.10 LEGIONELLA CONTROLL STRATEGY

In order to maintain disinfection of stored water, the heat pump controller and sensor positions are designed that a minimum 45% of stored water will reach a temperature of 60°C daily. However should you require it is possible to set an additional disinfection cycle being to 70°C weekly. This heating is done by from current temp to 70°C by the element & held for 32min.



ADD A LEGIONELLA BOOST CYCLE

In the functions menu select **FACTORY PARMETERS** then enter **PASSCODE: ??????** cycle through to **PARAMETER 66** click to change parameter from **0 TO 1**

MAINTENANCE - OWNER

13.1 SIX MONTH MAINTENANCE

The following maintenance should be performed by the owner of the heat pump every 6 months to ensure ongoing safety and performance.

1. PURGE THE PRESSURE TEMPERATURE RELIEF VALVE

It is recommended to operate the PTR valve periodically to ensure water flows freely. If water doesn't flow freely, the PTR valve will need to be replaced.

Locate the PTR valve on the left hand side of the unit.

Carefully release the valve using the lever & release some water from the tank.

WATER EXPELLED FROM VALVE MAY BE EXTREMELY HOT



2. CHECK - AIR INTAKES/LID/CONDENSATE DRAIN - ARE FREE OF DEBRIS

It is recommended to check that the system lid and side intake grills are clear of debris.

The condensate pipe should be free of any blockages to allow flowing of condensate to drain.



MAINTENANCE - TRADESPERSON

It is recommended that qualified tradespeople perform the following maintenance every FIVE YEARS.

1. CHECK PLUMBING VALVES

It is recommended to ensure that all valves connected to the heat pump are operating properly. Faulty valves should be replaced.

2. CHECK BACKUP MAGNESIUM ANODE

The anode protects the inner lining of your hot water tank. When the anode become degraded the level of protection is diminished. It is recommended that anode is periodically checked for its level of degradation and gets replaced if required.

- Turn off the power and turn off the cold water inlet valve.
- Open a hot water tap and decrease the pressure of the inner container.
- Open the drain port and drain remaining water completely in the release about 20L water.
- Remove the side cover by removing the screws, locate the anode position behind the cover.
- Unscrew the anode using 3/4" socket and pull out- Check for degradation.
- If still in suitable condition, refit ensuring an effective seal
- If anode is in an unsuitable condition, replace with a new one, ensuring an effective seal.
- Reopen the cold water inlet valve.
- Open a hot water tap until hot water flows out, then turn off the hot water tap.
- Turn on the power to restart the unit, now the unit can be used as normal.

3. DRAIN TANK

It is recommended to clean the inner tank and electric heating element regularly to maintain efficient performance.

- Turn off the power and turn off the cold water inlet valve.
- Close the cold water inlet valve & open a hot water tap.
- Use a flexible pipe to connect the drain port to a suitable sewage drain. (Note: The min. heat resistance of the drain pipe must not be less than 93°, if the drain pipe does not meet the requirement, please open the cold water inlet valve & open a hot water tap, until the temperature of the water is suitable for the drain pipe).
- Open the drain port of the water heater; drain out all the water in the inner tank. If it is needed, use water to wash the inner tank several times to clear the deposits.
- Close the drain port, re-fill the inner tank with water, and turn the power back on.

- P.T.R VALVE - Should be free draining and free of leaks.
- E.C.V VALVE (IF INSTALLED) - Should be free draining and free of leaks.
- TEMPERING VALVE - Water should be no hotter then 50°C at sanitary outlets.
- PRESSURE REDUCTION VALVE - Incomming pressure to tank should be >500kPa
- CHECK BACKUP MAGNESIUM ANODE - If consumed replace.
- DRAIN TANK

TROUBLE SHOOTING - OWNER

NO HOT WATER

POSSIBLE CAUSES	CHECKS	SOLUTIONS
System has no power and cannot heat	Check to see if the control screen is illuminated.	If the screen is blank, check the supply power switch is turned on and that all homes fuses are up. If all fuses are down, contact your electrician or energy provider to ensure there is power going to the system.
Issue with the home's tempering valve.	Check TANK temperature by releasing water from PTR.	If the water from PTR temperature is hotter than the temperature at your taps, contact your installing plumber to service/replace the home's tempering valve.
Issues with the system's temperature sensor	Check the TANK temperature on the screen.	If the TANK temperature is showing above 70°C or displaying fault alarm, turn the power off to the system for 30 minutes to reset. If the error continues when power is turned back on contact 1300 769 904 to arrange service.
Issue with the heat pump or controller settings.	Check the controller is shows SHOWER symbol. Check timers are all OFF.	Change MODE to ELEMENT call 1300 769 904 to arrange service.

RUNNING OUT OF HOT WATER

POSSIBLE CAUSES	CHECKS	SOLUTIONS
High flow shower heads installed	Call plumber to check home's shower heads.	Plumber can replace shower heads or install water flow valves to reduce your hot water usage
System is on an off-peak tariff	Check with energy provider that the system not on an off-peak tariff	Switch to a continuous power supply tariff.
System timers are set with too small a recovery period.	Check control for clock symbol is illuminated.	Contact us on 1300 769 904 to discuss timer options and modes.
Wrong Mode Selected	Check the controller to see what mode selected	Change MODE to HYBRID or HYBRID+

IF THE ABOVE ISSUES ARE RESOLVED AND YOU ARE STILL RUNNING OUT OF HOT WATER, CONTACT US ON 1300 769 904 DURING OFFICE HOURS AND A TECHNICIAN CAN ASSIST.

CONDENSATE AND/OR PTR LEAKING

Owners can expect at least 5 -10L of water to be drained daily from condensate and relief valves during the systems heating. If more than a bucket a day of water is being drained contact your installing plumber to check all relief valves.

ADJUSTING THE HOT WATER TEMPERATURE

All hot water systems must be installed with a tempering valve that limits the water temperature at showers and bath outlets to a maximum of 50°C. Adjusting the systems thermostat will not result in hotter water at these outlets. If you require a higher temperature at your kitchen or laundry taps, please discuss with your installing plumber about possible solutions.

LOW HOT WATER PRESSURE

The hot water pressure available at your taps is dependent on your homes incoming water mains pressure as well as any pressure restricting or tempering valves, your plumber may have installed. The heat pump does not control or limit the hot water pressure delivery in anyway. If the pressure at your hot water taps is significantly reduced compared to your cold-water taps, contact your installing plumber.

NOISE ISSUES

POSSIBLE CAUSES	CHECKS	SOLUTIONS
System running times	Check control for clock symbol is illuminated..	To minimise noise impact we recommend setting the system to run between 7:00 am and 19:00 pm
Vibration in refrigerant circuit	Check if the noise source is predominatly from the left hand side of system.	Take video to send to tech support for confirmation system is running per specs. call 1300 769 904
Fan running noise	Check if the noise source is predominatly from the right hand side system.	Take video to send to tech support for confirmation system is running per specs. call 1300 769 904

ADJUST FAN HIGH & LOW SPEED RUNNING PARAMETERS

If the heat pump is installed in an environment that amplifies fan acoustics, such as near fences or other barriers, adjustments can be made to the fan programming. By changing, the majority of heating can be done under low wind speed conditions, reducing noise lev& disturbance to the property and neighbours. This will result in reduction to efficiency of 5 - 10%.

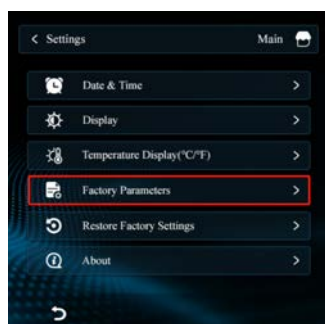

In the functions menu select **FACTORY PARAMETERS** then enter **PASSCODE: ??????** cycle through to **PARAMETER 30** change to **10**
PARAMETER 35 change to **30**

WARRANTY - AUSTRALIA ONLY



The DYNAMIC/X8 comprehensive 6 year warranty covers all system parts and tank in full, including any labour charges. Have peace of mind that you'll be covered.

SIX YEAR SYSTEM WARRANTY

Aquatech Solar Technologies Pty. Ltd. warrants the Hydrotherm DYNAMIC/X8 will be free from minor defects and major failures for a period of 6 years from the date of system installation. When proof of installation date is not provided, the start date of the warranty will commence from the system date of manufacture determined by the systems unique serial identifier.

This warranty covers only Hydrotherm - DYNAMIC/X8 systems sold and installed in Australia with serial number begins with HYD8.

MINOR DEFECTS

A minor defect is determined by an approved service agent or the Aquatech Solar Technologies Pty. Ltd. service department and is classified as a repairable non-critical failure of a system part or parts. Owners can claim reimbursement for the following costs associated with a minor defect:

All parts under section 4.2 DYNAMIC/X8 PARTS SCHEMATICS will be supplied free of charge for a period of for a period of 6 years from the date of installation, provided that proof of purchase is provided. If proof of purchase is not supplied, the coverage will be valid from the date of manufacture.

Aquatech Solar Technologies Pty. Ltd. will cover all labour costs associated with fitting or replacing of listed parts by their approved service agent or service department for a period of 6 years from the date of installation, provided that proof of purchase is provided. If proof of purchase is not supplied, the coverage will be valid from the date of manufacture.

MAKING A MINOR DEFECTS CLAIM

The following steps should be taken when making a warranty claim with Aquatech Solar Technologies Pty. Ltd:

1. Owners experiencing issues with their system are to contact Aquatech Solar Technologies Pty. Ltd. service department directly on 1300 769 904 during operating hours.
2. If your issue can not be dealt with over the phone, owners will be supplied with details of service agent in their area.
3. Owners will need to contact and deal with service agents directly in relation to the booking and payments of works related to the service or repair of their system.
4. Owners can claim reimbursement for costs of parts covered under schematic 4.2 DYNAMIC/X8 PARTS SCHEMATICS and for onsite labour charges covered if completed by an approved Service Agent or Aquatech Solar Technologies Pty. Ltd. service department. To claim reimbursement of costs by completing an Minor Online Claim

- Proof of purchase/installation to validate system age, if not supplied system age will be determined from date of manufacture.
- Copy of invoice from an Aquatech Solar Technologies Pty. Ltd. approved service agent or Aquatech Solar Technologies Pty. Ltd. service department.
- All Service Claim Submissions will be processed and reimbursement on validated claim paid into owner nominated account within 7 business days.

MAJOR FAILURES

A major failure is classed as a non-repairable critical failure making the system not fit for use defined by either of the following two parameters:

1. The System storage tank will be free from leaks under operating and water chemistry conditions per below table

TANK WARRANTY CONDITIONS

INLET PRESSURE	PH RANGE	CHLORIDE
>500kPa	6 - 8	> 250mg

2. The System will provide sufficient performance as to guarantee a heating capacity equal to meet a medium load demand for the climate zone it has been installed in, as outlined AS/NZS 4692.1:2005., when connected to a continuous power supply.

A major failure can only be validated by an Aquatech approved service agent or plumber, or by the Aquatech Solar Technologies Pty. Ltd. service department. If a major failure is validated an approved agent will need to complete a Major Failure System Report (contact Aquatech Solar Technologies for a copy of report document).

Owners will be required to support their warranty claim by providing a Major Failure System Report document as well as proof of original purchase, such as invoice for the supply or installation of the system for which a warranty claim is being made against.

MAJOR FAILURES

The following steps should be taken when making a warranty claim with Aquatech Solar Technologies Pty. Ltd:

1. Owners experiencing issues with their system are to contact Aquatech Solar Technologies Pty. Ltd. service department directly on 1300 769 904 during operating hours.
2. If your issue can not be dealt with over the phone, owners will be supplied with details of service agent in their area.
3. Owners will need to contact and deal with service agents directly in relation to the booking and payments of works related to the service or repair of their system.
4. If an attending Aquatech approved service agent determines that the system has a non-repairable fault resulting in a Major Failure they will generate a Major Failure System Report and submit to owner along with a copy of their invoice for attending the job.

5. Owners must submit the following documents to: warranty@hydrothermhotwatersystems.com.au to validate a Major Failure Claim:
 - Major Failure System Report completed by approved Aquatech Service Agent
 - An original purchase invoices or installation invoice to prove ownership and to determine that the system has not been relocated or altered from the original install.
6. A Major Failure can only be claimed for a period of 6 Years from the date of system install. Owners who can support their claim of a Major Failure within 6 Years of the date of install, will be supplied with a free system of equal or similar tank and heating capacity, depending on models available at time of claim. Owners will be entitled to any and all Government subsidies that maybe available to them at the time of the supply of a free system., any claims to such subsidies will be the responsibility of the owner.

The replacement system will be made available for collection from the closet Aquatech Warehouse or distributor to the owner’s address. Any associated cost for shipping and or delivery of the free replacement system from said warehouse and or distributor will be at the owner’s expense and therefore are not covered under the warranty terms and conditions. This includes any costs required to locate the system into the installation location. The owner is responsible for any and all costs associated with the installation of the replacement system by a licensed tradesman of their choosing.

If a free replacement system is supplied in the event of a Major Failure Claim, any and all warranties will be determined based on the date of the original system as prescribed in the Major Failure System Report and not the date of the replacement system. For purpose of future warranty claims the replacement system will be prescribed the same serial number as the original system. All warranty claims made against the replacement system will be treated without prejudice up to 6 Years from the date of the original system installation determined by either proof of purchase, or Major Failure System Report, and failing the supply of these documents the original date of manufacture.

Owners can claim reimbursement for the following costs associated with a Major Failure: The labour costs incurred in the generation of a Major Failure System Report, when said costs have been itemised on invoices from an Aquatech approved Service Agent or Plumbers.

DOMESTIC WARRANTY COMPONENTS SUMMARY

TANK	ELECTRONICS	REFRIGERATION	VALVES
6 Years	6 Years	6 Years	1 Year
The system storage tank will be free from leaks when installed under defined conditions. Should failure occur a Major Failure Claim can be issued.	All electronics as listed in Scematic 4.2 will be supplied free of charge including cost to install for period of 6 Years from D.O.M or Install	The system will provide sufficient heating performance as defined. Should failure occur a Major Failure Claim can be issued.	Valves supplied packaged with the system are provided by 3rd party manufactures and are covered for 1 YEAR parts & labour warranty only.

WARRANTY EXCLUSIONS

This warranty does not cover any costs associated with the failure or damage of the DYNAMIC/X8 system under the following circumstances:

1. Any failure of listed parts or complete system where the systems has not been installed in compliance with installation instruction as outlined in the Hydrotherm DYNAMIC/X8 Installation and User Guide Document and all statutory and local requirements of the state in which the water heater is installed.
2. Any damage to system components that are aesthetic in nature and do not impact on the system performance or ability to provide hot water. These include but are not limited to: corrosion that does not effect structural integrity (e.g. tea staining), dents or other visual defects.
3. Damage to parts due to miss handling of system in transport or during installation.
4. Accidental damage including: Acts of God, misuse use of system, repairs to system not completed by approved Aquatech Solar Technologies Pty. Ltd. service agent. or Aquatech-Solar Technologies Pty. Ltd. service department.
5. Any failure of parts where electrical supply currents and voltages have exceeded the specified 240V supply by more than a 10% variance.
6. Any failure of parts due to noise in the electrical supply.
7. Any failure of parts not outlined in section 2.2 SCHEMATIC HYDROTHERM DYNAMIC/X8 of this document including any parts supplied and installed during the installation of system.
8. Any associated plumbing parts including the PTR Valve, which is covered by third party suppliers, have a one-year warranty (parts & labour).
9. Failure of the Hydrotherm DYNAMIC/X8 system or any associated parts as a result of damaged from insects or animals.
10. Installations where the pipe work has been connecte directly to the condensate drain elbow, without a sufficient air gap.
11. Subject to any statutory provisions to the contrary, this warranty excludes any and all claims for damage to furniture, carpets, walls, foundations or any other consequential loss either directly or indirectly due to leakage from the system or due to leakage from fittings and/or pipe work of metal, plastic or other materials caused by water temperature, workmanship or other modes.
12. Subject to any statutory provisions to the contrary, this warranty excludes any and all claims for damage to furniture, carpets, walls, foundations or any other consequential loss either directly or indirectly due to fire from the system or due to fire from fittings and/or pipe work of metal, plastic or other materials connected to the system, workmanship or other modes.

AUSTRALIAN CONSUMER LAW

Our goods come with guarantees that cannot be excluded under the Australian Consumer Law. You are entitled to a replacement or refund for a major failure and for compensation for any other reasonably foreseeable loss or damage. You are also entitled to have the goods repaired or replaced if the goods fail to be of acceptable quality and the failure does not amount to a major failure.

The warranty (set out above) is in addition to any rights and remedies that you may have under the Australian Consumer Law.

NON-RESIDENTIAL WARRANTY

Where the DYNAMIC/X8 has been installed in any capacity not related to the supply of potable hot water at a temperature not in excess of 60°C, the installation will be deemed as nonresidential and all warranties are void.

NON-RESIDENTIAL WARRANTY

The DYNAMIC/X8 has been rated to meet a medium load delivery per AS/NZS 4692.1:2005 across all five climate zones. Where the average daily hot water demand made on a single DYNAMIC/X8 system is shown to be 150% or above medium load demand for the climate zone in which it has been installed as outlined in AS/NZS 4692.1:2005. Or if the property where the system is installed is not installed in a single-family domestic dwelling. The installation will be classed as a commercial installation and therefore fall under the following warranty terms.

COMMERCIAL WARRANTY COMPONENTS SUMMARY

TANK	ELECTRONICS	REFRIGERATION	VALVES
3 Years	3 Years	3 Years	1 Year
Should failure occur replacement system, supplied free of charge. Installation and repair labour costs are the responsibility of the owner.	All electronics as listed in Scematic 4.2 will be supplied free of charge including cost to install for period of 3 Years from D.O.M or Install	Should failure occur replacement system, supplied free of charge. Installation and repair labour costs are the responsibility of the owner.	Valves supplied packaged with the system are provided by 3rd party manufactures and are covered for 1 YEAR parts & labour warranty only.

NON-RESIDENTIAL WARRANTY

The DYNAMIC/X8 is designed to operate with an independent cold-water feed. Installing the system on a circulating feed, where hot water will be re-entering the system, will void all warranties. This includes manifolding multiple systems as a single installation.

SUPPLIED PTR &/OR OTHER VAVLES

The DYNAMIC/X8 is supplied with a 3rd party PTR valve and may also be supplied with other valves as part of promotional offers. All supplied valves come with a warranty period of 1 Year parts & labour from the date of installation or manufacture as per the 3rd party suppliers terms and conditions. Any repairs/replacement relating to supplied valves that are over 12 months will need to be arranged by owner. If required Aquatech Solar Technologies may provide a list of plumbers that can assist.

IF YOU REQUIRE ANY ASSISTANCE WITH A WARRANTY CLAIM PLEASE CONTACT US ON 1300 769 904 DURING OFFICE HOURS.



INFO@HYDROTHERMHOTWATERSYSTEMS.COM.AU

WWW.HYDROTHERMHOTWATERSYSTEMS.COM.AU

1300 769 904